

Flat Products



TABLE OF CONTENTS

Introduction.....	3
L-Gibs Bronze-Plated, Inch	4
V-Gibs Bronze-Plated, Inch	5
L-Gibs Solid-Bronze, Self-Lubricating, Inch.....	6
L-Gibs Solid-Bronze, Self-Lubricating, Metric.....	7
Square Gibs.....	8
Gib Assemblies.....	9
Base Plates for Gib Assemblies	10
Optional T-Slide for Gib Assemblies	11
L-Gibs for Gib Assemblies	12
Wear Strip Ways, Self-Lubricating.....	13
Wear Strips, Bronze-Plated, Inch	14
Wear Strips, Bronze-Plated, Metric	16
Side Strips, Bronze-Plated, Inch and Metric.....	17
Wear Strips, Solid-Bronze, Self-Lubricating, Inch - Fixed Length ..	18
Automotive Wear Plates	
VDI Metric.....	20
Automotive Wear Plate Conversions	22
NAAMS Metric.....	24
Guide Blocks	
Corner.....	27
Inch.....	28
Metric.....	30
Keeper Blocks	
Inch, Light Duty.....	32
Inch, Medium Duty.....	34
Inch, Heavy Duty	36
Metric, 6mm.....	38
Metric, 13mm.....	39
U & V Blocks, NAAMS.....	40
Center Keys & Guides	42

Lamina, Inc. began as a lamination die manufacturer in 1938. During the years from 1938 to the present Lamina has evolved into a manufacturer and distributor of die and mold components. Even though we no longer make dies, we do understand the die and mold maker's needs and objectives.

We have made it our business to supply quality products in a timely manner at a reasonable price. We know how to compete in the marketplace and supply you with the products you need when you need them.

With the introduction of this catalog featuring sliding guide components for molds, machinery and dies, we bring you

a wider selection of wear and guiding products than in the past. It is our purpose to help you become more productive by helping to eliminate your downtime. With the products in stock, we will become your one-stop supplier and deliver the products you require each and every day.

Our catalog is presented in an easy-to-read format that will display the selection of products you need without a lot of extra data.

BRONZE-PLATED WEAR STRIPS & GIBS

Bronze-Plated Wear Strips & Gibs are made from low carbon extra-fine grain steel electroplated with a bronze alloy consisting of approximately 89% copper and 11% tin. The hardness is 180 BHN minimum. Lamina Bronze Plating has a natural lubricity and is ideal when used against hardened steel. We recommend any good grade of light machine oil suitable for machine way applications to extend the life of the wear surface.

The thickness of the bronze is .008 to .010". By using this thickness the bronze does not funnel out under heavy loads. The strength of steel backing keeps surface distortion to a minimum. Because most precision tool slide applications require either reworking or replacement if they develop so much as a .003 wear, Lamina Bronze thickness is more than adequate.

The superior wear properties of Lamina Bronze is not affected in working temperatures up to 400° F.

- Precision Machining on L-Gibs
- Precision ground sliding surface on wearstrips
- Close tolerances
- Consistent quality control
- Low Friction: Co-efficient of friction .2518
- Load factor 2700 PSI
- No galling or snow balling
- Magnetic - can be held on magnetic chuck
- Non-abrasive
- Non Seizing

BRONZE SELF-LUBRICATING WEAR STRIPS AND GIBS

Bronze Self-Lubricating wear strips and gibs are made from bronze with self-lubricating graphite plugs. These products can be used in applications up to 450° F (232°C).

Bronze is a strong material that resists wear, abrasion and deformation under high compressive loads.

Oil-impregnated graphite plugs cover 25-30% of the wear surface, providing a self-lubricating film of graphite on the wear surface.

Applying a film or mist of light machine oil on new self-lubricating parts before use, will enhance the self-lubricating properties. (Do not use grease on graphite-plugged surfaces.)

- Precision machining on L-Gibs
- Self Lubricating
- Precision ground wear surfaces on wearstrips
- Close tolerances
- Consistent quality control
- Resists abrasion
- Excellent wear characteristics

We would also like to remind you that these parts run best and last longest in a clean environment.

L-Gibs – Inch

Bronze-Plated Steel
With and without
graphite plugs

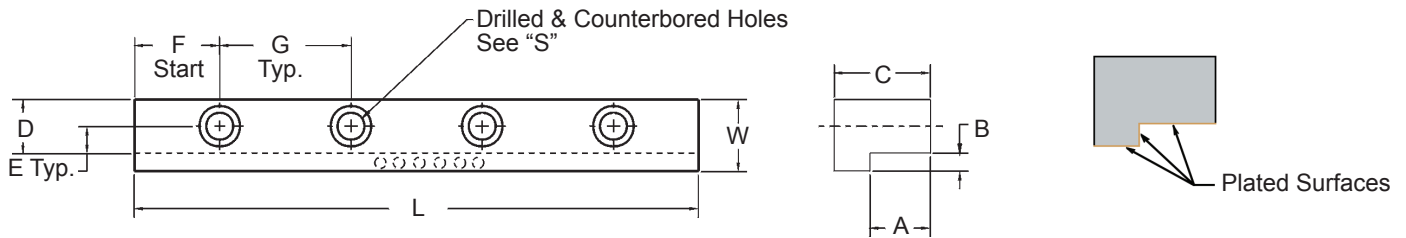
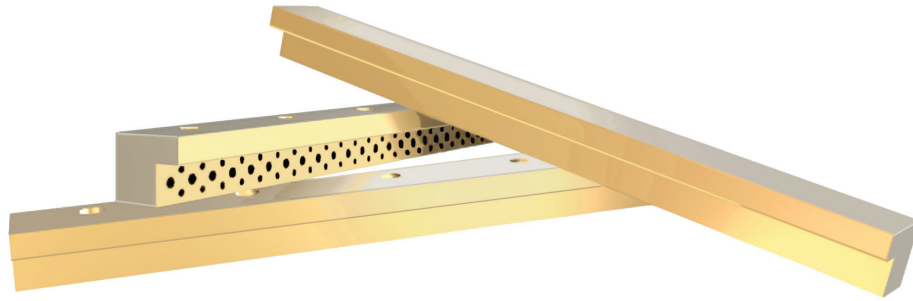

Standard L-Gibs with and without mounting holes
Self-Lubricating L-Gibs with and without mounting holes

Hole Location ± 0.05
Unless noted, all dimensions ± 0.10

L-GIBS – INCH – BRONZE-PLATED – PLAIN & SELF-LUBRICATING												
PART NUMBER	PART NUMBER (Self-Lubricating)	L	W	A GH	B GW	C	D	E	F	G	S	
											Qty	Size
			$^{+.000}$ $_{-.005}$	$^{+.001}$ $_{-.000}$	$^{+.000}$ $_{-.005}$			± 0.005				
L-4-6-3	N/A	5.25	.75	.312	.188	.485	.562	.281	.875	1.750	3	1/4"
L-4-6-4	N/A	7.00									4	
L-4-6-5	SLL-4-6-5	8.75									5	
L-4-6-5-NH	SLL-4-6-NH	8.75									NO MOUNTING HOLES	
L-5-8-3	N/A	6.00	1.00	.375	.250	.610	.750	.375	1.000	2.000	3	5/16"
L-5-8-4	N/A	8.00									4	
L-5-8-5	SLL-5-8-5	10.00									5	
L-5-8-5-NH	SLL-5-8-NH	10.00									NO MOUNTING HOLES	
L-7-10-3	N/A	7.50	1.25	.500	.375	.860	.875	.437	1.250	2.500	3	3/8"
L-7-10-4	N/A	10.00									4	
L-7-10-5	SLL-7-10-5	12.50									5	
L-7-10-5-NH	SLL-7-10-NH	12.50									NO MOUNTING HOLES	
L-10-12-3	N/A	9.00	1.50	.750	.500	1.235	1.000	.500	1.500	3.000	3	3/8"
L-10-12-4	N/A	12.00									4	
L-10-12-5	SLL-10-12-5	15.00									5	
L-10-12-5-NH	SLL-10-12-NH	15.00									NO MOUNTING HOLES	
L-12-16-4	N/A	16.00	2.00	.875	.625	1.470	1.375	.687	2.000	4.000	4	1/2"
L-12-16-6	SLL-12-16-6	24.00									6	
L-12-16-6-NH	SLL-12-16-NH	24.00									NO MOUNTING HOLES	
L-16-20-6	N/A	24.00	2.50	1.250	.750	1.970	1.750	.875	2.000	4.000	6	5/8"
L-16-20-8	SLL-16-20-8	32.00									8	
L-16-20-8-NH	SLL-16-20-NH	32.00									NO MOUNTING HOLES	
L-20-24-5	N/A	30.00	3.00	1.500	1.000	2.470	2.000	1.000	3.000	6.000	5	5/8"
L-20-24-8	SLL-20-24-8	48.00									8	
L-20-24-8-NH	SLL-20-24-NH	48.00									NO MOUNTING HOLES	



V-Gibs –Inch 60°

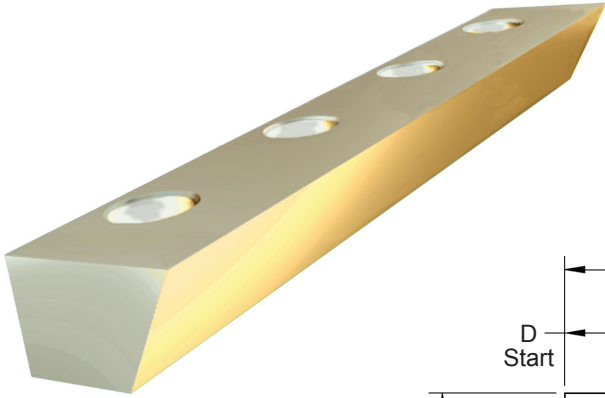

Bronze-Plated Steel

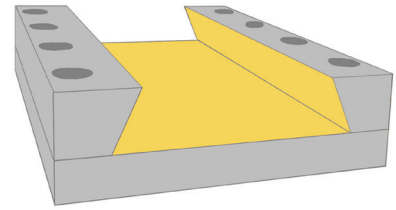

Use Lamina V-Gibs and Wear Strips right from stock to create assemblies.

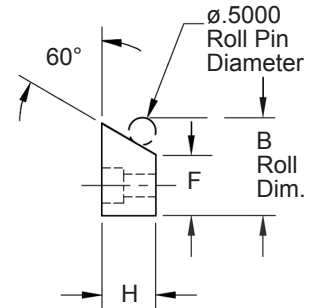
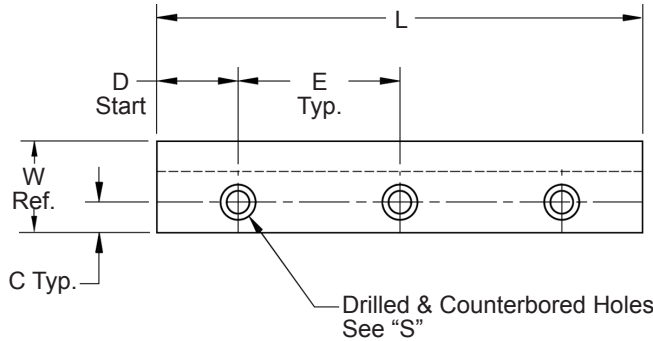

Only Lamina stocks standard V-Gibs

Hole location $\pm .005$
Unless noted, all dimensions $\pm .010$

V-GIBS – BRONZE PLATED										
PART NUMBER	L	W Ref.	H	F Base Width	B Roll Dim.	C	D	E	S	
			+ .000 - .005	+ .000 - .001	+ .000 - .001	+ .000 - .005			No. Holes	Size
V-5-7-3	5.25	.92	.610	.562	1.2455	.281	.875	1.750	3	1/4"
V-5-7-4	7.00								4	
V-5-7-5	8.75								5	
V-6-10-3	6.00	1.18	.735	.750	1.4330	.375	1.000	2.000	3	5/16"
V-6-10-4	8.00								4	
V-6-10-5	10.00								5	
V-7-11-3	7.50	1.38	.860	.875	1.5580	.437	1.250	2.500	3	3/8"
V-7-11-4	10.00								4	
V-7-11-5	12.50								5	
V-8-12-3	9.00	1.70	.985	1.125	1.8080	.562	1.500	3.000	3	3/8"
V-8-12-4	12.00								4	
V-8-12-5	15.00								5	
V-10-16-4	16.00	1.97	1.235	1.250	1.9330	.625	2.000	4.000	4	1/2"
V-10-16-6	24.00								6	
V-12-20-6	24.00	2.49	1.470	1.625	2.3080	.812	2.000	4.000	6	5/8"
V-12-20-8	32.00								8	
V-14-24-5	30.00	3.01	1.720	2.000	2.6830	1.000	3.000	6.000	5	5/8"
V-14-24-8	48.00								8	
V-16-32-8	48.00	3.90	1.970	2.750	3.4330	1.375	3.000	6.000	8	3/4"

Lamina Bronze electroplated on steel has achieved universal acceptance for wear applications. The Lamina principle of using bronze for wear surfaces and steel for strength is seen on many products throughout the Lamina product line.

- Plating thickness: .008 – .010
- One-piece construction with pre-drilled and counter-bored screw holes, machined complete.

L-Gib – Inch

- Plastics Injection Molds
- Special Machines
- Press Gibbing
- Special Slide Applications

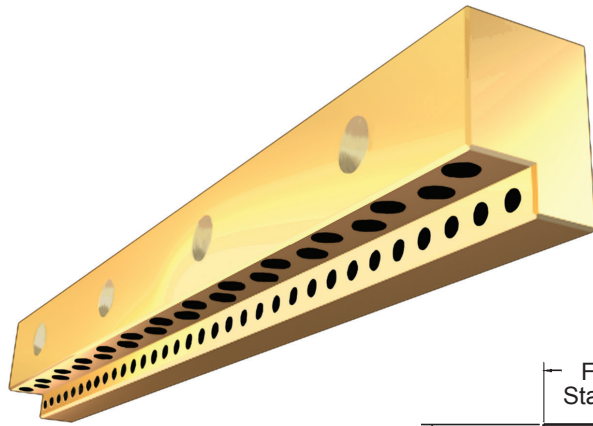

Bronze with
Self-Lubricating
Graphite Plugs

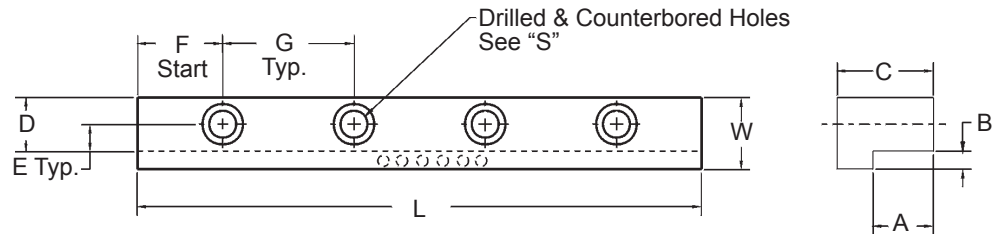

For L-Gibs without mounting holes use "N" at the end of the part number.

Unless noted, all dimensions ± 0.10

L-GIBS – INCH – SOLID BRONZE – SELF-LUBRICATING											
PART NUMBER	L	W +0.000 -0.005	A GH +0.001	B GW -0.000	C +0.000 -0.005	D	E	F	G	M	
										No. Holes	Size
L2LG42G	5.25	.75	.312	.188	.75	.56	.281	.875	1.750	3	1/4"
L2LG56G	7.00							.875		4	
L2LG70G	8.75							.875		5	
L3LG48G	6.00	1.00	.375	.250	.75	.75	.375	1.000	2.000	3	5/16"
L3LG64G	8.00							1.000		4	
L3LG80G	10.00							1.000		5	
L4LG48G	6.00	1.25	.500	.375	.88	.87	.437	1.000	2.000	3	3/8"
L4LG60G	7.50							1.250		3	
L4LG80G	10.00							1.250		4	
L4LG100G	12.50							1.250		5	
L6LG48G	6.00	1.50	.750	.500	1.25	1.00	.500	1.000	2.000	3	3/8"
L6LG72G	9.00							1.500		3	
L6LG96G	12.00							1.500		4	
L6LG120G	15.00							1.500		5	
L7LG64G	8.00	2.00	.875	.625	1.50	1.37	.687	1.000	2.000	4	1/2"
L7LG96G	12.00							1.500		4	
L7LG128G	16.00							2.000		4	
L10LG96G	12.00	2.50	1.250	.750	2.00	1.75	.875	1.500	3.000	4	5/8"
L10LG144G	18.00							2.250		4	
L10LG192G	24.00							3.000		4	
L12LG96G	12.00	3.00	1.500	1.000	2.50	2.00	1.000	1.500	3.000	4	5/8"
L12LG144G	18.00							2.250		4	
L12LG192G	24.00							3.000		4	

L-Gib – Metric

- Plastics Injection Molds
- Special Machines
- Press Gibbing
- Special Slide Applications

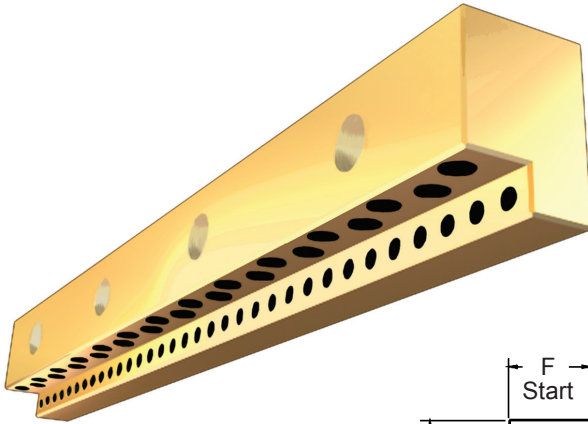

Bronze with Self-Lubricating Graphite Plugs

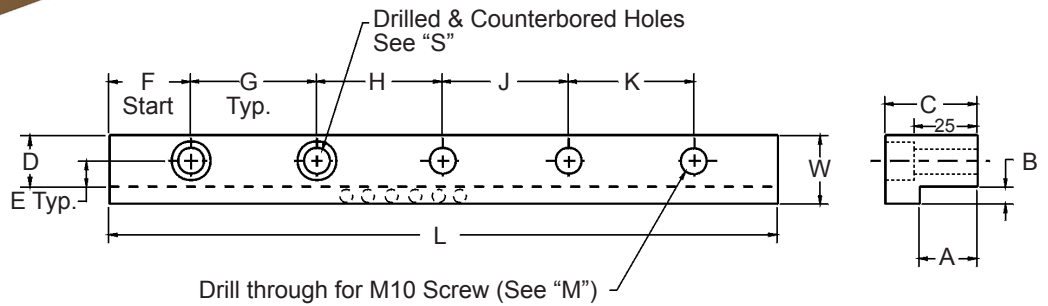

Precision machined sliding surfaces

Unless noted, all dimensions $\pm 0.25\text{mm}$

L-GIBS – METRIC – SOLID BRONZE – SELF-LUBRICATING															
PART NUMBER	L	W +0.00 -0.13	A		C	D	E	F	G	H	J	K	QUANTITY		M & S Size
			GH	GW									M	S	
L15LG100G	100	32	15	10	30	22	11	20	-	-	-	60	2	-	M10
L15LG150G	150								-	55	-	55	3	-	
L15LG200G	200								55	-	50	55	4	-	
L15LG250G	250								70	-	70	70	4	-	
L25LG200G	200	50	25	22	45	28	14		55	-	50	55	-	4	
L25LG250G	250								70	-	70	70	-	4	
L25LG300G	300								65	65	65	65	-	5	
L25LG350G	350								80	75	75	80	-	5	

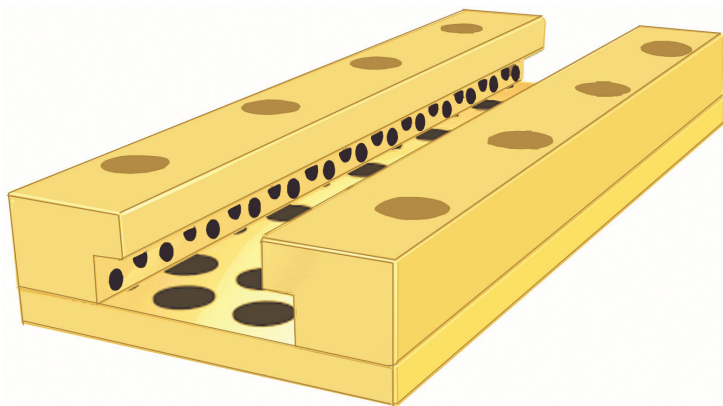

The variety of sizes offered make custom gib and slide assembly construction fast and easy.

During normal sliding action, graphite produces a lubricating film across the entire wear surface.

It is recommended that a mist of light oil be wiped on sliding surface prior to assembly.

One piece construction with pre-drilled and counterbored screw holes, machined complete.

Lamina off-the-shelf L-Gibs and Wear Strips can be put together to make your own custom assemblies..

Square Gibs



Bronze with
Self-Lubricating
Graphite Plugs

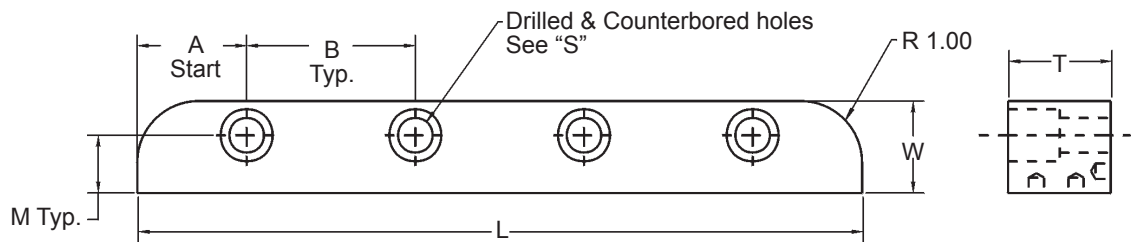

Unless noted, all Dimensions $\pm .010$

SQUARE GIBS – BRONZE – SELF-LUBRICATING								
PART NUMBER	L	W +.000 -.005	T +.000 -.005	A	B $\pm .005$	M $\pm .005$	S	
							No. Holes	Size
L6SG32G	4.00	1.00	.75	1.000	2.000	.625	2	3/8"
L6SG40G	5.00				1.500		3	
L6SG48G	6.00				2.000		3	
L6SG64G	8.00				2.000		4	
L6SG80G	10.00				2.000		5	
L6SG96G	12.00				2.000		6	
L6SG96NG	12.00	NO MOUNTING HOLES						
L8SG32G	4.00	1.25	1.00	1.000	2.000	.875	2	3/8"
L8SG40G	5.00				1.500		3	
L8SG48G	6.00				2.000		3	
L8SG64G	8.00				2.000		4	
L8SG80G	10.00				2.000		5	
L8SG96G	12.00				2.000		6	
L8SG96NG	12.00	NO MOUNTING HOLES						
L12SG64G	8.00	2.00	1.50	1.500	2.500	1.250	3	5/8"
L12SG80G	10.00			1.250	2.500		4	
L12SG96G	12.00			1.500	3.000		4	
L12SG96NG	12.00	NO MOUNTING HOLES						

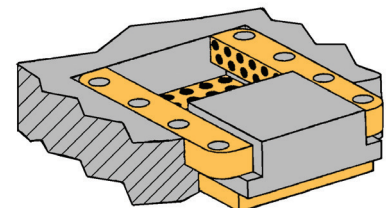
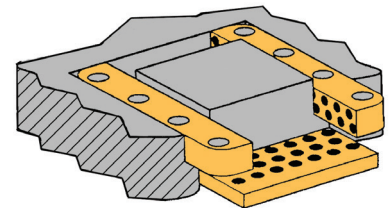

**Create custom gib
assemblies using Lamina
component parts.**

Gib Assemblies – Inch

- Plastics Injection Molds
- Special Machines
- Special Slide Applications



Bronze with
Self-Lubricating
Graphite Plugs

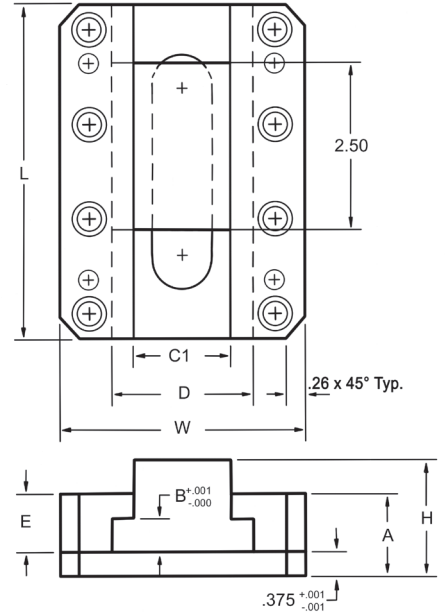

PRODUCT FEATURES

The gib assembly includes four components: two L-gibs, a base plate, and an optional T-slide. The L-gibs are provided with screw holes and are spot drilled for dowels. Also, the base plate includes thru holes to allow for easy assembly and fit into a pre-machined pocket. The gib assembly is a proven performer in a wide variety of applications, including lifter slides in molds.

NOTE:

◆ Refer to page 11 for T-Slide dimensional information.

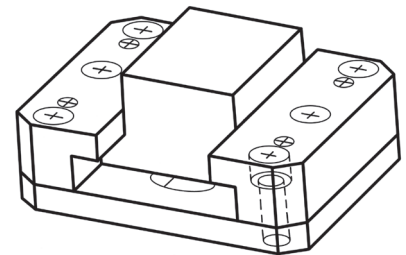

GIB ASSEMBLIES – INCH													
ASSY. WITH T-SLIDE PART NUMBER	ASSY. WITHOUT T-SLIDE PART NUMBER	L	W +.000 -.005	A	B +.001 -.000	C1	D	E	H	Socket Head Cap Screws		Locating Dowel Pins	
										No. Holes	Size	No. Holes	Size
L2GA16GTS	L2GA16G	2.00	2.620	1.12	.312	1.12	1.50	.75	1.63	4	1/4-20x1-1/4	4	1/4 x 1-1/2
L2GA24GTS	L2GA24G	3.00								4			
L2GA32GTS	L2GA32G	4.00								6			
L3GA24GTS	L3GA24G	3.00	3.120	1.12	.375	1.12	1.62	.75	1.62	4	5/16-18x1-1/2	4	1/4 x 1-1/2
L3GA32GTS	L3GA32G	4.00								6			
L3GA40GTS	L3GA40G	5.00								6			
L4GA24GTS	L4GA24G	3.00	4.120	1.25	.500	1.62	2.37	.88	1.75	4	5/16-18x1-1/2	4	1/4 x 1-1/2
L4GA32GTS	L4GA32G	4.00								6			
L4GA40GTS	L4GA40G	5.00								6			
L4GA48GTS	L4GA48G	6.00								8			
L6GA32GTS	L6GA32G	4.00	4.620	1.62	.750	1.62	2.62	1.25	2.13	6	5/16-18x1-3/4	4	1/4 x 1-3/4
L6GA40GTS	L6GA40G	5.00								6			
L6GA48GTS	L6GA48G	6.00								8			

Base Plates for Gib Assemblies

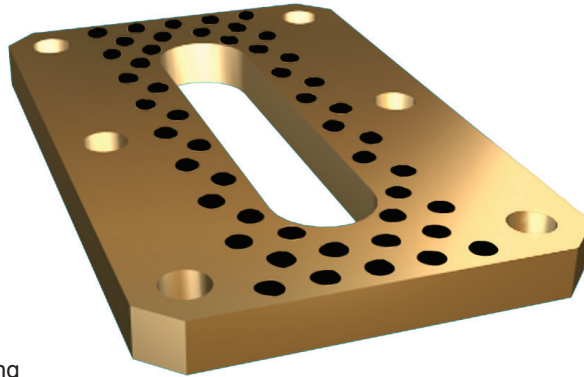

Bronze with
Self-Lubricating
Graphite Plugs

NOTE:

◆ See page 9 for complete assembly.

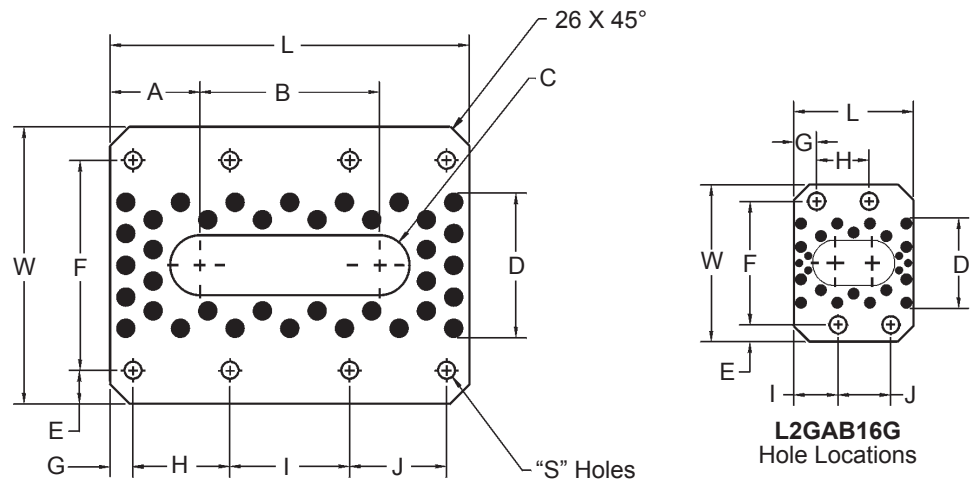

Thickness = .375"

Unless noted, all dimensions ± 0.010

GIB ASSEMBLY BASE PLATES														
PART NUMBER	L	W +.000 -.005	A	B	C	D	E	F	G	H	I	J	S	
													NO.	SIZE
L2GAB16G	2.00	2.620	.69	.62	.38	1.50	.280	2.060	.380	.880	.740	.880	4	1/4"
L2GAB24G	3.00		.88	1.24						-	-	2.240	4	
L2GAB32G	4.00		1.00	2.00						1.620	-	1.620	6	
L3GAB24G	3.00	3.120	.88	1.24	.38	1.68	.370	2.380	.380	-	-	2.240	4	5/16"
L3GAB32G	4.00		1.00	2.00						1.620	-	1.620	6	
L3GAB40G	5.00		1.12	2.76						2.120	-	2.120	6	
L4GAB24G	3.00	4.120	1.00	1.00	.50	2.25	.495	3.130	.380	-	-	2.240	4	5/16"
L4GAB32G	4.00		1.12	1.76						1.620	-	1.620	6	
L4GAB40G	5.00		1.25	2.50						2.120	-	2.120	6	
L4GAB48G	6.00		1.50	3.00						1.620	2.000	1.620	8	
L6GAB32G	4.00	4.620	1.12	1.76	.50	2.41	.560	3.500	.380	1.620	-	1.620	6	5/16"
L6GAB40G	5.00		1.25	2.50						2.120	-	2.120	6	
L6GAB48G	6.00		1.50	3.00						1.620	2.000	1.620	8	

Optional T-Slide for Gib Assemblies – Inch

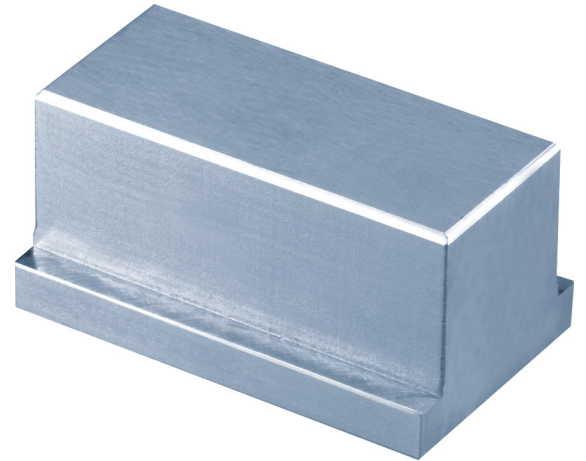
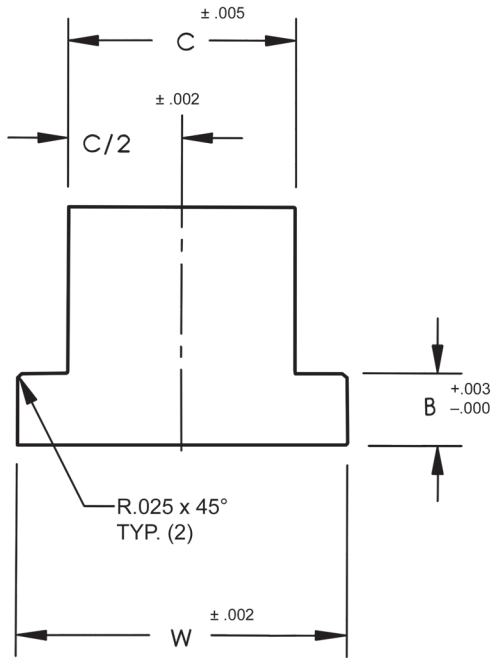

High quality
carburized steel

NOTE:

◆ See page 9 for complete assembly.

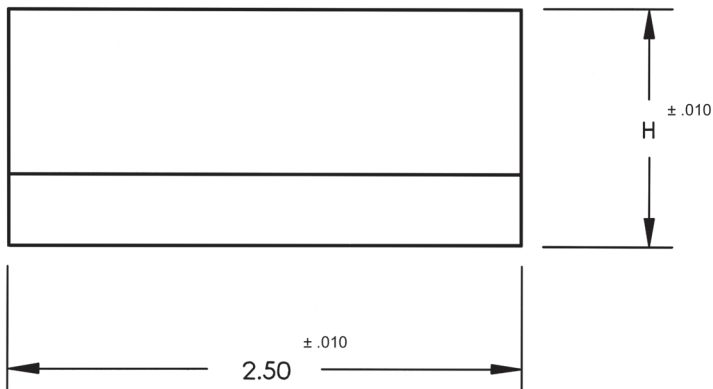

PRODUCT FEATURES

The inch-sized T-Slide is often used as a Lifter Slide and can be purchased separately or as a part of the gib assembly.

T-SLIDE FOR GIB ASSEMBLIES – INCH					
Part Number	Width W (in)	B (in)	C (in)	C/2 (in)	Height H (in)
2GASLIDE	1.493	0.308	1.110	0.555	1.25
3GASLIDE	1.617	0.371	1.110	0.555	1.25
4GASLIDE	2.367	0.496	1.610	0.805	1.38
6GASLIDE	2.617	0.746	1.610	0.805	1.75

L-Gibs for Gib Assemblies

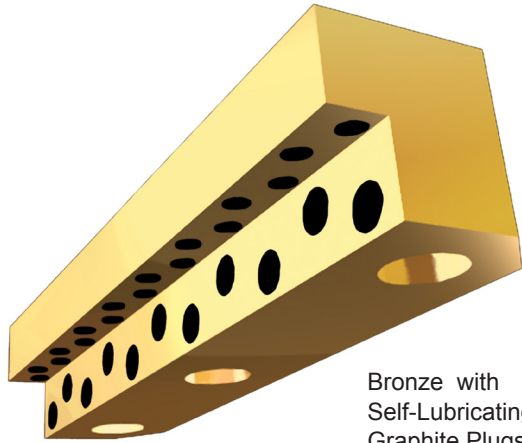

Bronze with
Self-Lubricating
Graphite Plugs

NOTE:

◆ See page 9 for complete assembly.

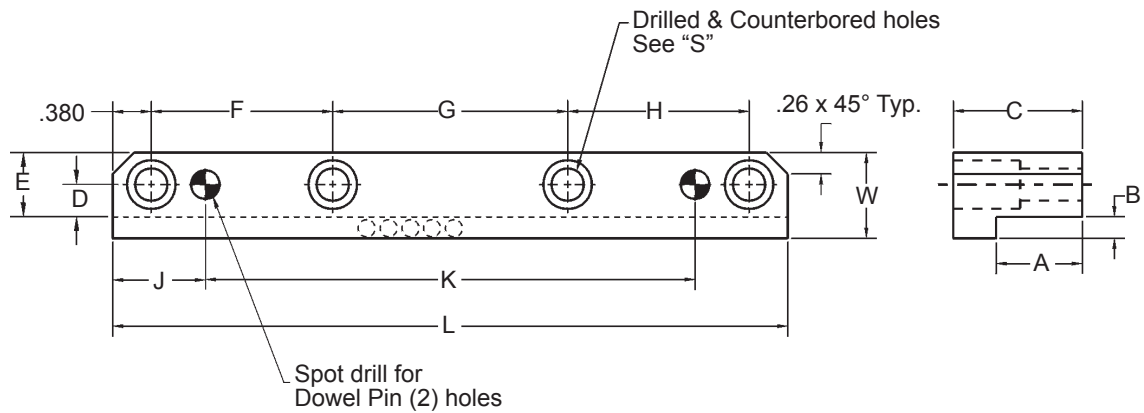

Precision machined sliding surface

Unless noted, all dimensions ± 0.010

GIB ASSEMBLY L-GIBS															
PART NUMBER	L	W +.000 -.005	A		C +.000 -.005	D	E	F	G	H	J	K	S		
			GH	B GW -.000									NO.	SIZE	
L2GAL16G	2.00	.75	.312	.188	.75	.280	.56	-	.880	-	.79	.95	2	1/4"	
L2GAL24G	3.00							-	-	2.240	.88	1.24	2		
L2GAL32G	4.00							1.620	-	1.620	.88	2.24	3		
L3GAL24G	3.00	1.00	.375	.250	.75	.380	.75	-	-	2.240	.88	1.24	2	5/16"	
L3GAL32G	4.00							1.620	-	1.620		.88	2.24		3
L3GAL40G	5.00							2.120	-	2.120		.88	3.24		3
L4GAL24G	3.00							-	-	2.240		.88	1.24		2
L4GAL32G	4.00	1.620	-	1.620	2.24	3									
L4GAL40G	5.00	2.120	-	2.120	3.24	3									
L4GAL48G	6.00	1.620	2.000	1.620	4.24	4									
L6GAL32G	4.00	1.50	.750	.500	1.25	.440	1.00	1.620	-	1.620	.88	2.24	3	5/16"	
L6GAL40G	5.00							2.120	-	2.120		3.24	3		
L6GAL48G	6.00							1.620	2.000	1.620		4.24	4		

Wear Strip Ways – Solid Bronze – Graphite Plugs

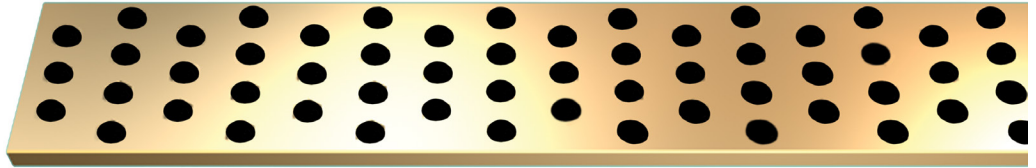

Bronze with
Self-Lubricating
Graphite Plugs

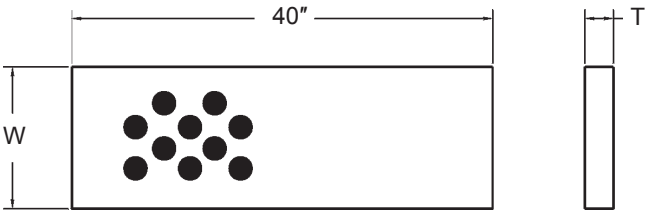

Call Lamina Customer Service for hole pattern.

WEAR STRIP WAYS			
PART NUMBER	T ±.001	W	PLUG DIA.
L312-320NG	0.375	1.50	5/16
L316-320NG		2.00	3/8
L320-320NG		2.50	3/8
L324-320NG		3.00	1/2
L412-320NG	0.500	1.50	5/16
L416-320NG		2.00	3/8
L420-320NG		2.50	3/8
L424-320NG		3.00	1/2
L432-320NG		4.00	1/2
L516-320NG	0.625	2.00	3/8
L524-320NG		3.00	1/2
L532-320NG		4.00	1/2
L616-320NG	0.750	2.00	3/8
L624-320NG		3.00	1/2
L632-320NG		4.00	1/2
L640-320NG		5.00	1/2



Wear Strips – Bronze Plated

Lamina bronze-plated wear strips are offered cut at 1/8" increments or in 48" lengths. Example: FP-1/4-x-2-1.125 (per 1/8 inch, decimal)

WEAR STRIPS – INCH – BRONZE-PLATED														
BRONZE PLATED		T Thick- ness +.000 -.002	W Width +.000 -.080	BRONZE PLATED		T Thick- ness +.000 -.002	W Width +.000 -.080	BRONZE PLATED		T Thick- ness +.000 -.002	W Width +.000 -.080			
PART NUMBER by the inch	PART NUMBER 48" length			PART NUMBER by the inch	PART NUMBER 48" length			PART NUMBER by the inch	PART NUMBER 48" length					
FP-1/8-x-1	PPF013100	1/8"	1	FP-5/16-x-1	PPF031100	5/16"	1	FP-5/8-x-1	PPF063100	5/8"	1			
FP-1/8-x-1-1/4	PPF013125		1-1/4	FP-5/16-x-1-1/4	PPF031125		1-1/4	FP-5/8-x-1-1/4	PPF063125		1-1/4			
FP-1/8-x-1-1/2	PPF013150		1-1/2	FP-5/16-x-1-1/2	PPF031150		1-1/2	FP-5/8-x-1-1/2	PPF063150		1-1/2			
FP-1/8-x-1-3/4	PPF013175		1-3/4	FP-5/16-x-1-3/4	PPF031175		1-3/4	FP-5/8-x-1-3/4	PPF063175		1-3/4			
FP-1/8-x-2	PPF013200		2	FP-5/16-x-2	PPF031200		2	FP-5/8-x-2	PPF063200		2			
FP-1/8-x-2-1/2	PPF013250		2-1/2	FP-5/16-x-2-1/2	PPF031250		2-1/2	FP-5/8-x-2-1/2	PPF063250		2-1/2			
FP-1/8-x-3	PPF013300		3	FP-5/16-x-3	PPF031300		3	FP-5/8-x-3	PPF063300		3			
FP-1/8-x-3-1/2	PPF013350		3-1/2	FP-5/16-x-3-1/2	PPF031350		3-1/2	FP-5/8-x-3-1/2	PPF063350		3-1/2			
FP-1/8-x-4	PPF013400		4	FP-5/16-x-4	PPF031400		4	FP-5/8-x-4	PPF063400		4			
FP-1/8-x-4-1/2	PPF013450		4-1/2	FP-5/16-x-4-1/2	PPF031450		4-1/2	FP-5/8-x-4-1/2	PPF063450		4-1/2			
FP-1/8-x-5	PPF013500		5	FP-5/16-x-5	PPF031500		5	FP-5/8-x-5	PPF063500		5			
FP-1/8-x-6	PPF013600		6	FP-5/16-x-6	PPF031600		6	FP-5/8-x-6	PPF063600		6			
FP-3/16-x-1	PPF019100		3/16"	1	FP-5/16-x-8		PPF031800	3/8"	8		FP-5/8-x-8	PPF063800	3/4"	8
FP-3/16-x-1-1/4	PPF019125			1-1/4	FP-5/16-x-10		PPF0311000		10		FP-5/8-x-10	PPF0631000		10
FP-3/16-x-1-1/2	PPF019150	1-1/2		FP-5/16-x-12	PPF0311200	12	FP-5/8-x-12		PPF0631200	12				
FP-3/16-x-1-3/4	PPF019175	1-3/4		FP-3/8-x-1	PPF038100	1	FP-3/4-x-1		PPF075100	1				
FP-3/16-x-2	PPF019200	2		FP-3/8-x-1-1/4	PPF038125	1-1/4	FP-3/4-x-1-1/4		PPF075125	1-1/4				
FP-3/16-x-2-1/2	PPF019250	2-1/2		FP-3/8-x-1-1/2	PPF038150	1-1/2	FP-3/4-x-1-1/2		PPF075150	1-1/2				
FP-3/16-x-3	PPF019300	3		FP-3/8-x-1-3/4	PPF038175	1-3/4	FP-3/4-x-1-3/4		PPF075175	1-3/4				
FP-3/16-x-3-1/2	PPF019350	3-1/2		FP-3/8-x-2	PPF038200	2	FP-3/4-x-2		PPF075200	2				
FP-3/16-x-4	PPF019400	4		FP-3/8-x-2-1/2	PPF038250	2-1/2	FP-3/4-x-2-1/2		PPF075250	2-1/2				
FP-3/16-x-4-1/2	PPF019450	4-1/2		FP-3/8-x-3	PPF038300	3	FP-3/4-x-3		PPF075300	3				
FP-3/16-x-5	PPF019500	5		FP-3/8-x-3-1/2	PPF038350	3-1/2	FP-3/4-x-3-1/2		PPF075350	3-1/2				
FP-3/16-x-6	PPF019600	6		FP-3/8-x-4	PPF038400	4	FP-3/4-x-4		PPF075400	4				
FP-3/16-x-8	PPF019800	8	FP-3/8-x-4-1/2	PPF038450	4-1/2	FP-3/4-x-4-1/2	PPF075450	4-1/2						
FP-1/4-x-1	PPF025100	1/4"	1	FP-3/8-x-5	PPF038500	1/2"	5	FP-3/4-x-5	PPF075500	1"	5			
FP-1/4-x-1-1/4	PPF025125		1-1/4	FP-3/8-x-6	PPF038600		6	FP-3/4-x-6	PPF075600		6			
FP-1/4-x-1-1/2	PPF025150		1-1/2	FP-3/8-x-8	PPF038800		8	FP-3/4-x-8	PPF075800		8			
FP-1/4-x-1-3/4	PPF025175		1-3/4	FP-3/8-x-10	PPF0381000		10	FP-3/4-x-10	PPF0751000		10			
FP-1/4-x-2	PPF025200		2	FP-3/8-x-12	PPF0381200		12	FP-3/4-x-12	PPF0751200		12			
FP-1/4-x-2-1/2	PPF025250		2-1/2	FP-1/2-x-1	PPF050100		1	FP-1-x-1	PPF100100		1			
FP-1/4-x-3	PPF025300		3	FP-1/2-x-1-1/4	PPF050125		1-1/4	FP-1-x-1-1/4	PPF100125		1-1/4			
FP-1/4-x-3-1/2	PPF025350		3-1/2	FP-1/2-x-1-1/2	PPF050150		1-1/2	FP-1-x-1-1/2	PPF100150		1-1/2			
FP-1/4-x-4	PPF025400		4	FP-1/2-x-1-3/4	PPF050175		1-3/4	FP-1-x-1-3/4	PPF100175		1-3/4			
FP-1/4-x-4-1/2	PPF025450		4-1/2	FP-1/2-x-2	PPF050200		2	FP-1-x-2	PPF100200		2			
FP-1/4-x-5	PPF025500		5	FP-1/2-x-2-1/2	PPF050250		2-1/2	FP-1-x-2-1/2	PPF100250		2-1/2			
FP-1/4-x-6	PPF025600		6	FP-1/2-x-3	PPF050300		3	FP-1-x-3	PPF100300		3			
FP-1/4-x-8	PPF025800	8	FP-1/2-x-3-1/2	PPF050350	3-1/2	FP-1-x-3-1/2	PPF100350	3-1/2						
FP-1/4-x-10	PPF0251000	10	FP-1/2-x-4	PPF050400	4	FP-1-x-4	PPF100400	4						
FP-1/4-x-12	PPF0251200	12	FP-1/2-x-4-1/2	PPF050450	4-1/2	FP-1-x-4-1/2	PPF100450	4-1/2						
Create custom assemblies using standard Lamina component parts.				FP-1/2-x-5	PPF050500	5	FP-1-x-5	PPF100500	5					
				FP-1/2-x-6	PPF050600	6	FP-1-x-6	PPF100600	6					
				FP-1/2-x-8	PPF050800	8	FP-1-x-8	PPF100800	8					
				FP-1/2-x-10	PPF0501000	10	FP-1-x-10	PPF1001000	10					
				FP-1/2-x-12	PPF0501200	12	FP-1-x-12	PPF1001200	12					

Wear Strips – Bronze-Plated

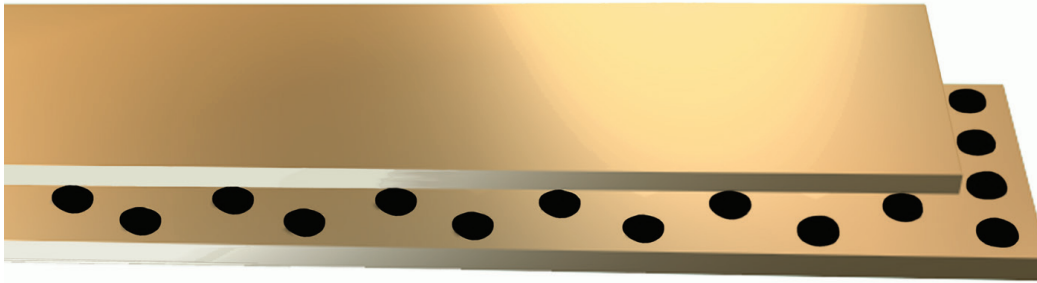

Standard wear strips are plated on one side only.

Up to four sides can be plated. Please call for quotation.

PLAIN

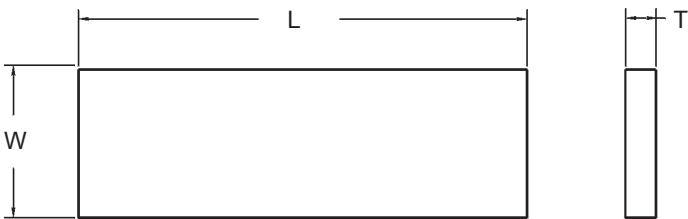

Maximum length 48"

SELF-LUBRICATING

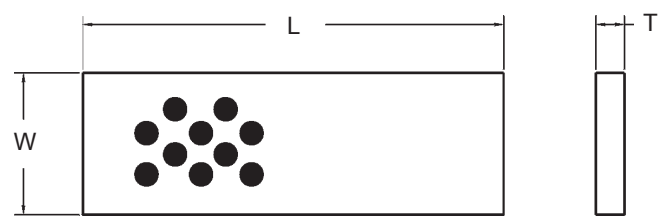

Maximum length 48"

In order to be flat this material must be fastened to a flat surface.

- Parallel .001 within 4'
- Thickness of bronze: .008 to .010
- Milled edges

Machining may cause distortion which can result in the loss of flatness of the part. Once altered, Lamina will not replace wear strips. We can provide specials at a reasonable price. Send your prints to sales@lamina.com

Wear Strips – Bronze-Plated & Self-Lubricating

WEAR STRIPS – INCH – BRONZE-PLATED – SELF-LUBRICATING											
PART NUMBER		T	W	PART NUMBER		T	W	PART NUMBER		T	W
By the inch	48" length	Thick-ness +.000 -.002	Width +.000 -.080	By the inch	48" length	Thick-ness +.000 -.002	Width +.000 -.080	By the inch	48" length	Thick-ness +.000 -.002	Width +.000 -.080
SLFP025-100	SLF025100	1/4"	1	SLFP050-100	SLF050100	1/2"	1	SLFP100-100	SLF100100	1"	1
SLFP025-150	SLF025150		1-1/2	SLFP050-150	SLF050150		1-1/2	SLFP100-150	SLF100150		1-1/2
SLFP025-200	SLF025200		2	SLFP050-200	SLF050200		2	SLFP100-200	SLF100200		2
SLFP025-250	SLF025250		2-1/2	SLFP050-250	SLF050250		2-1/2	SLFP100-250	SLF100250		2-1/2
SLFP025-300	SLF025300		3	SLFP050-300	SLF050300		3	SLFP100-300	SLF100300		3
SLFP025-400	SLF025400		4	SLFP050-400	SLF050400		4	SLFP100-400	SLF100400		4
SLFP025-500	SLF025500		5	SLFP050-500	SLF050500		5	SLFP100-500	SLF100500		5
SLFP025-600	SLF025600		6	SLFP050-600	SLF050600		6	SLFP100-600	SLF100600		6
SLFP038-100	SLF038100	3/8"	1	SLFP075-100	SLF075100	3/4"	1	These products are in stock at Lamina and at Lamina stocking distributors throughout the world.			
SLFP038-150	SLF038150		1-1/2	SLFP075-150	SLF075150		1-1/2				
SLFP038-200	SLF038200		2	SLFP075-200	SLF075200		2				
SLFP038-250	SLF038250		2-1/2	SLFP075-250	SLF075250		2-1/2				
SLFP038-300	SLF038300		3	SLFP075-300	SLF075300		3				
SLFP038-400	SLF038400		4	SLFP075-400	SLF075400		4				
SLFP038-500	SLF038500		5	SLFP075-500	SLF075500		5				
SLFP038-600	SLF038600		6	SLFP075-600	SLF075600		6				

Lamina bronze-plated self-lubricating wear strips are offered cut in 1/8" increments or in 48" lengths. Example: SLFP038-500-1.125 (per 1/8 inch, decimal). We suggest cutting these strips in 1/2" increments to avoid cutting through the plugs.

Wear Strips – Bronze-Plated – FP Metric

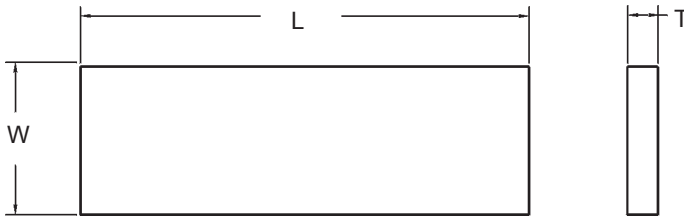

Maximum length 1219 mm

Standard wear strips are plated on one side only.

Up to four sides can be plated, please call for a quotation.

- In order to be flat this material must be fastened to a flat surface.
- Parallel 0.025 within 1219mm
- Thickness of bronze: 0.20 to 0.25
- Milled edges

Machining may cause distortion which can result in the loss of flatness of the part. Once altered, Lamina will not replace wear strips. We can provide specials at a reasonable price. Send your prints to sales@lamina.com

Lamina bronze-plated wear strips are offered cut at 5mm increments or in 1219mm lengths. Example: FP-10MM-X-25-15 (per 5mm)

WEAR STRIPS – METRIC – BRONZE-PLATED												
BRONZE PLATED		T Thick- ness +0.0 -0.051	W Width +0.000 -2.032	BRONZE PLATED		T Thick- ness +0.0 -0.051	W Width +0.000 -2.032	BRONZE PLATED		T Thick- ness +0.0 -0.051	W Width +0.000 -2.032	
PART NUMBER by 25mm	PART NUMBER 1219mm length			PART NUMBER by 25mm	PART NUMBER 1219mm length			PART NUMBER by 25mm	PART NUMBER 1219mm length			
FP-4MM-X-25	MFP04025	4mm	25mm	FP-10MM-X-25	MFP10025	10mm	25mm	FP-20MM-X-30	MFP20030	20mm	30mm	
FP-4MM-X-30	MFP04030		30mm	FP-10MM-X-30	MFP10030		30mm	FP-20MM-X-50	MFP20050		50mm	
FP-4MM-X-35	MFP04035		35mm	FP-10MM-X-35	MFP10035		35mm	FP-20MM-X-60	MFP20060		60mm	
FP-4MM-X-40	MFP04040		40mm	FP-10MM-X-40	MFP10040		40mm	FP-20MM-X-75	MFP20075		75mm	
FP-4MM-X-60	MFP04060		60mm	FP-10MM-X-50	MFP10050		50mm	FP-20MM-X-100	MFP20100	100mm		
FP-4MM-X-100	MFP04100		100mm	FP-10MM-X-60	MFP10060		60mm	FP-25MM-X-25	MFP25025	25mm	25mm	
FP-5MM-X-25	MFP05025	25mm	FP-10MM-X-75	MFP10075	75mm	FP-25MM-X-100	MFP25100	100mm				
FP-5MM-X-30	MFP05030	5mm	30mm	FP-10MM-X-100	MFP10100	10mm	100mm	Lamina is the only manufacturer of bronze-plated wear strips.				
FP-5MM-X-40	MFP05040		40mm	FP-10MM-X-125	MFP10125		125mm					
FP-5MM-X-75	MFP05075		75mm	FP-10MM-X-150	MFP10150		150mm					
FP-5MM-X-100	MFP05100		100mm	FP-12MM-X-50	MFP12050		12mm					50mm
FP-6MM-X-25	MFP06025		25mm	FP-12MM-X-75	MFP12075							75mm
FP-6MM-X-30	MFP06030	30mm	FP-12MM-X-100	MFP12100	100mm							
FP-6MM-X-35	MFP06035	35mm	FP-12MM-X-125	MFP12125	125mm							
FP-6MM-X-40	MFP06040	6mm	40mm	FP-12MM-X-150	MFP12150	150mm						
FP-6MM-X-50	MFP06050		50mm	FP-12MM-X-200	MFP12200	200mm						
FP-6MM-X-60	MFP06060		60mm	FP-15MM-X-25	MFP15025	15mm	25mm					
FP-6MM-X-75	MFP06075		75mm	FP-15MM-X-40	MFP15040		40mm					
FP-8MM-X-25	MFP08025	25mm	FP-15MM-X-60	MFP15060	60mm							
FP-8MM-X-60	MFP08060	60mm	FP-15MM-X-75	MFP15075	75mm							
FP-8MM-X-75	MFP08075	75mm	FP-15MM-X-100	MFP15100	100mm							
FP-8MM-X-100	MFP08100	8mm	100mm	FP-15MM-X-125	MFP15125	125mm						
FP-8MM-X-125	MFP08125		125mm	FP-15MM-X-150	MFP15150	150mm						

Side Strip – Bronze-Plated – SP Inch & Metric

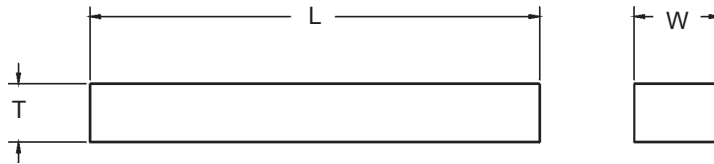

NOTE:

- ◆ Maximum length is 48" (1219mm).

Lamina bronze-plated side strips are offered cut at 5mm increments or in 1219mm lengths. Example: SP-15MM-X-25MM-15 (per 5mm)

Lamina bronze-plated side strips are offered cut in 1/8" increments or in 48" lengths. Example: SP-1/2-X-1-1.125 (per 1/8 inch, decimal)

SIDE STRIP – METRIC			
BRONZE-PLATED		T Thickness -0.45 -0.50	W Width +0.0 -0.12
PART NUMBER by 25mm	PART NUMBER 1219mm length		
SP-15MM-X-25MM	MSP15025	15	25
SP-25MM-X-37MM	MSP25037	25	37

SIDE STRIP – INCH			
BRONZE-PLATED		T THICK- NESS -.018 -.020	W WIDTH -.000 -.005
PART NUMBER by the Inch	PART NUMBER 48" length		
SP-1/2-X-1	SPF050100	1/2	1
SP-1/2-X-1-1/2	SPF050150		1-1/2
SP-5/8-X-1	SPF063100	5/8	1
SP-5/8-X-2	SPF063200		2
SP-3/4-X-1	SPF075100	3/4	1
SP-3/4-X-1-1/2	SPF075150		1-1/2
SP-3/4-X-2	SPF075200		2
SP-1-X-1-1/2	SPF100150	1	1-1/2
SP-1-X-2	SPF100200		2
SP-1-X-3	SPF100300		3
SP-1-1/4-X-2	SPF125200	1-1/4	2
SP-1-1/4-X-3	SPF125300		3
SP-1-1/2-X-2	SPF150200	1-1/2	2
SP-1-1/2-X-2-1/2	SPF150250		2-1/2
SP-2-X-2	SPF200200	2	2

Wear Strips – Inch – Fixed-Length

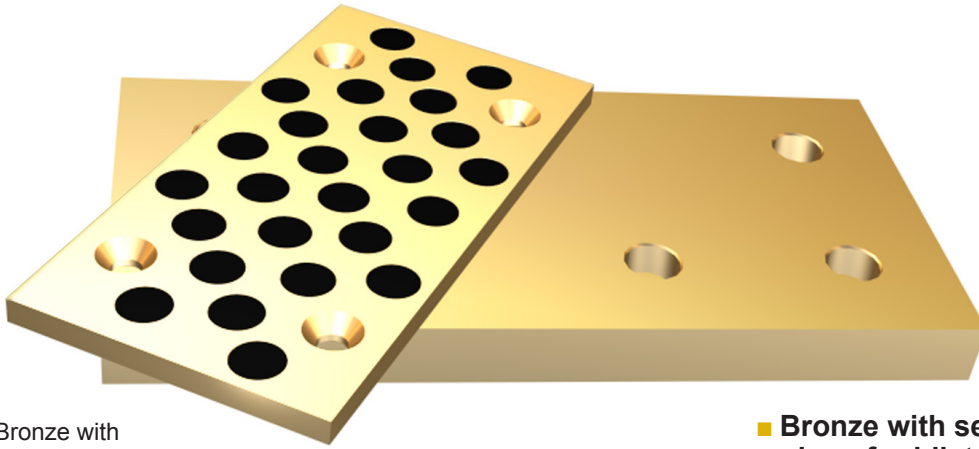

Bronze with
Self-Lubricating
Graphite Plugs

- Bronze with self-lubricating graphite plugs for bilateral wear
- Ready to use
- Solid Bronze available upon request

When ordering please indicate preference at the end of the part number:

- | | |
|---------------------------------------|--------------------|
| – No Graphite, with mounting holes | Example: L212-32 |
| G – With Graphite and mounting holes | Example: L212-32G |
| N – No Graphite, no mounting holes | Example: L212-32N |
| NG – With Graphite, no mounting holes | Example: L212-32NG |

Mounting hole patterns for Wear Strips

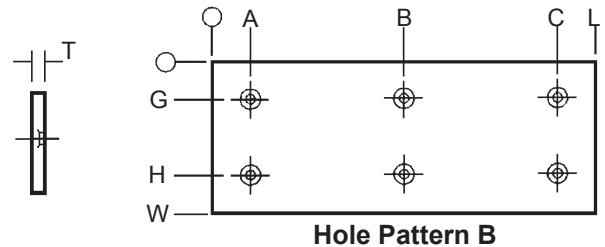
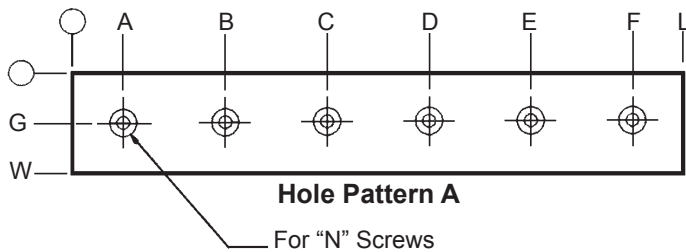

Material: Bronze
All Dimensions ± 0.010 unless noted

RECOMMENDED MOUNTING SCREW SIZES	
THICKNESS	N
1/4	1/4" Flat head screw
3/8	1/4" Socket head cap screw
1/2	5/16" Socket head cap screw
5/8	5/16" Socket head cap screw

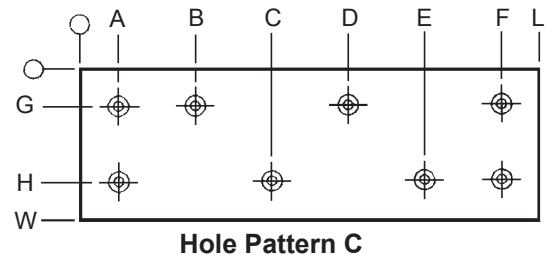

NOTE:

- ◆ Width and length of wearstrip determines hole pattern, regardless of thickness.



Wear Strips – Inch – Fixed-Length

Part numbers are for solid bronze.

Append “G”, “N”, or “NG” for self-lubricating graphite and mounting hole options – See previous page for details.

WEAR STRIPS – IMPERIAL															
PART NUMBER (Thickness)				W Width	L Length	SCREW HOLES		HOLE LOCATION							
1/4"	3/8"	1/2"	5/8"			AMT	PAT	A	B	C	D	E	F	G	H
L28-32	L38-32	-	-	1.00	4.00	2	A	1.00	3.00	-	-	-	-	.50	-
L28-40	L38-40	-	-		5.00	3		.50	2.50	4.50	-	-	-		
L28-48	L38-48	-	-		6.00	3		1.00	3.00	5.00	-	-	-		
L28-64	L38-64	-	-		8.00	4		1.00	3.00	5.00	7.00	-	-		
L28-80	L38-80	-	-		10.00	5		1.00	3.00	5.00	7.00	9.00	-		
L28-96	L38-96	-	-		12.00	6		1.00	3.00	5.00	7.00	9.00	11.00		
-	-	L412-24	L512-24	1.50	3.00	2	A	.50	2.50	-	-	-	-	.75	-
L212-32	L312-32	L412-32	L512-32		4.00	2		1.00	3.00	-	-	-	-		
L212-40	L312-40	L412-40	L512-40		5.00	3		.50	2.50	4.50	-	-	-		
L212-48	L312-48	L412-48	L512-48		6.00	3		1.00	3.00	5.00	-	-	-		
L212-64	L312-64	L412-64	L512-64		8.00	4		1.00	3.00	5.00	7.00	-	-		
L212-80	L312-80	L412-80	L512-80		10.00	5		1.00	3.00	5.00	7.00	9.00	-		
L212-96	L312-96	L412-96	L512-96	12.00	6	1.00	3.00	5.00	7.00	9.00	11.00				
-	-	L416-24	L516-24	2.00	3.00	2	A	.50	2.50	-	-	-	-	1.00	-
L216-32	L316-32	L416-32	L516-32		4.00	2		1.00	3.00	-	-	-	-		
L216-40	L316-40	L416-40	L516-40		5.00	3		.50	2.50	4.50	-	-	-		
L216-48	L316-48	L416-48	L516-48		6.00	3		1.00	3.00	5.00	-	-	-		
L216-64	L316-64	L416-64	L516-64		8.00	4		1.00	3.00	5.00	7.00	-	-		
L216-80	L316-80	L416-80	L516-80		10.00	5		1.00	3.00	5.00	7.00	9.00	-		
L216-96	L316-96	L416-96	L516-96	12.00	6	1.00	3.00	5.00	7.00	9.00	11.00				
-	-	L420-24	L520-24	2.50	3.00	2	A	.50	2.50	-	-	-	-	1.25	-
L220-32	L320-32	L420-32	L520-32		4.00	2		1.00	3.00	-	-	-	-		
L220-40	L320-40	L420-40	L520-40		5.00	3		.50	2.50	4.50	-	-	-		
L220-48	L320-48	L420-48	L520-48		6.00	3		1.00	3.00	5.00	-	-	-		
L220-64	L320-64	L420-64	L520-64		8.00	4		1.00	3.00	5.00	7.00	-	-		
L220-80	L320-80	L420-80	L520-80		10.00	5		1.00	3.00	5.00	7.00	9.00	-		
L220-96	L320-96	L420-96	L520-96	12.00	6	1.00	3.00	5.00	7.00	9.00	11.00				
-	-	L424-24	L524-24	3.00	3.00	4	B	.50	2.50	-	-	-	-	0.50	2.50
L224-32	L324-32	L424-32	L524-32		4.00	4		1.00	3.00	-	-	-	-		
L224-40	L324-40	L424-40	L524-40		5.00	4		.50	4.50	-	-	-	-		
L224-48	L324-48	L424-48	L524-48		6.00	4	1.00	5.00	-	-	-	-			
L224-64	L324-64	L424-64	L524-64		8.00	6	C	1.00	3.00	5.00	-	-	7.00		
L224-80	L324-80	L424-80	L524-80		10.00	6	B	1.00	5.00	9.00	-	-	-		
L224-96	L324-96	L424-96	L524-96	12.00	8	C	1.00	3.00	5.00	7.00	9.00	11.00			
L232-32	L332-32	L432-32	L532-32	4.00	4.00	4	B	1.00	3.00	-	-	-	-	1.00	3.00
L232-40	L332-40	L432-40	L532-40		5.00	4		.50	4.50	-	-	-	-		
L232-48	L332-48	L432-48	L532-48		6.00	4		1.00	5.00	-	-	-	-		
L232-64	L332-64	L432-64	L532-64		8.00	6	C	1.00	3.00	5.00	-	-	7.00		
L232-80	L332-80	L432-80	L532-80		10.00	6	B	1.00	5.00	9.00	-	-	-		
L232-96	L332-96	L432-96	L532-96		12.00	8	C	1.00	3.00	5.00	7.00	9.00	11.00		

Wear Plates – NAAMS Series W05, W06 & W07/VDI 3357 – Metric

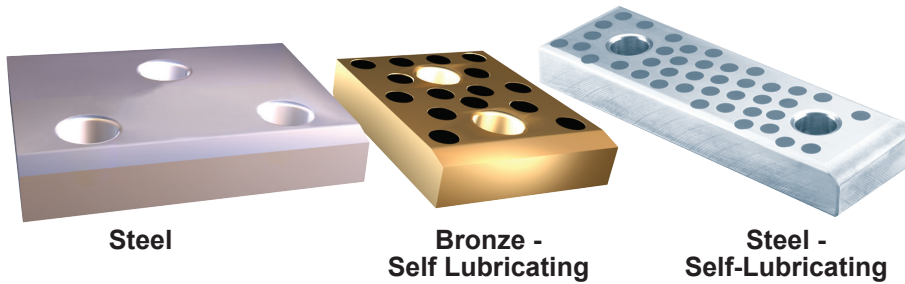

PRODUCT FEATURES

These wear plates are 20mm thick and available in bronze material with graphite, steel with graphite and plain steel.

VDI/NAAMS STANDARDS

Width W (mm)	Length L (mm)	Bronze w/Graphite Plugs	Steel w/Graphite Plugs	Steel Plain	Mounting Hole Pattern & Location						
					Hole	Hole	A	B	C	D	E
					Qty.	Pattern	(mm)	(mm)	(mm)	(mm)	(mm)
50	80	VDY050080	V DG050080	V DX050080	2	A-2	25	55	–	25	–
	100	VDY050100	V DG050100	V DX050100	2	A-2	25	75	–	25	–
	125	VDY050125	V DG050125	V DX050125	2	A-2	25	100	–	25	–
	160	VDY050160	V DG050160	V DX050160	2	A-2	25	135	–	25	–
	200	VDY050200	V DG050200	V DX050200	2	A-2	25	175	–	25	–
80	50	VDY080050	V DG080050	V DX080050	2	B-2	25	–	25	–	55
	80	VDY080080	V DG080080	V DX080080	2	A-2	25	55	–	40	–
	100	VDY080100	V DG080100	V DX080100	2	A-2	25	75	–	40	–
	125	VDY080125	V DG080125	V DX080125	2	A-2	25	100	–	40	–
	160	VDY080160	V DG080160	V DX080160	2	A-2	25	135	–	40	–
	200	VDY080200	V DG080200	V DX080200	2	A-2	25	175	–	40	–
	250	VDY080250	V DG080250	V DX080250	2	A-2	40	210	–	40	–
100	315	VDY080315	V DG080315	V DX080315	2	A-2	40	275	–	40	–
	50	VDY100050	V DG100050	V DX100050	2	B-2	25	–	25	–	75
	80	VDY100080	V DG100080	V DX100080	2	B-2	40	–	25	–	75
	100	VDY100100	V DG100100	V DX100100	2	A-2	25	75	–	50	–
	125	VDY100125	V DG100125	V DX100125	2	A-2	25	100	–	50	–
	160	VDY100160	V DG100160	V DX100160	2	A-2	25	135	–	50	–
	200	VDY100200	V DG100200	V DX100200	2	A-2	25	175	–	50	–
	250	VDY100250	V DG100250	V DX100250	2	A-2	40	210	–	50	–
125	315	VDY100315	V DG100315	V DX100315	2	A-2	40	275	–	50	–
	50	VDY125050	V DG125050	V DX125050	2	B-2	25	–	25	–	100
	80	VDY125080	V DG125080	V DX125080	2	B-2	40	–	25	–	
	100	VDY125100	V DG125100	V DX125100	3	B-3	25	75	25	62.5	
	125	VDY125125	V DG125125	V DX125125	3	B-3	25	100	25	62.5	
	160	VDY125160	V DG125160	V DX125160	3	B-3	25	135	25	62.5	
	200	VDY125200	V DG125200	V DX125200	3	B-3	25	175	25	62.5	
250	VDY125250	V DG125250	V DX125250	3	B-3	40	210	25	62.5		
160	315	VDY125315	V DG125315	V DX125315	3	B-3	40	275	25	62.5	
	50	VDY160050	V DG160050	V DX160050	2	B-2	25	–	25	–	135
	80	VDY160080	V DG160080	V DX160080	2	B-2	40	–	25	–	
	100	VDY160100	V DG160100	V DX160100	3	B-3	25	75	25	80	
	125	VDY160125	V DG160125	V DX160125	3	B-3	25	100	25	80	
	160	VDY160160	V DG160160	V DX160160	3	B-3	25	135	25	80	
	200	VDY160200	V DG160200	V DX160200	3	B-3	25	175	25	80	
	250	VDY160250	V DG160250	V DX160250	4	C-4	40	210	25	–	
315	VDY160315	V DG160315	V DX160315	4	C-4	40	275	25	–		

Wear Plates – NAAMS Series W05, W06 & W07/VDI 3357 – Metric

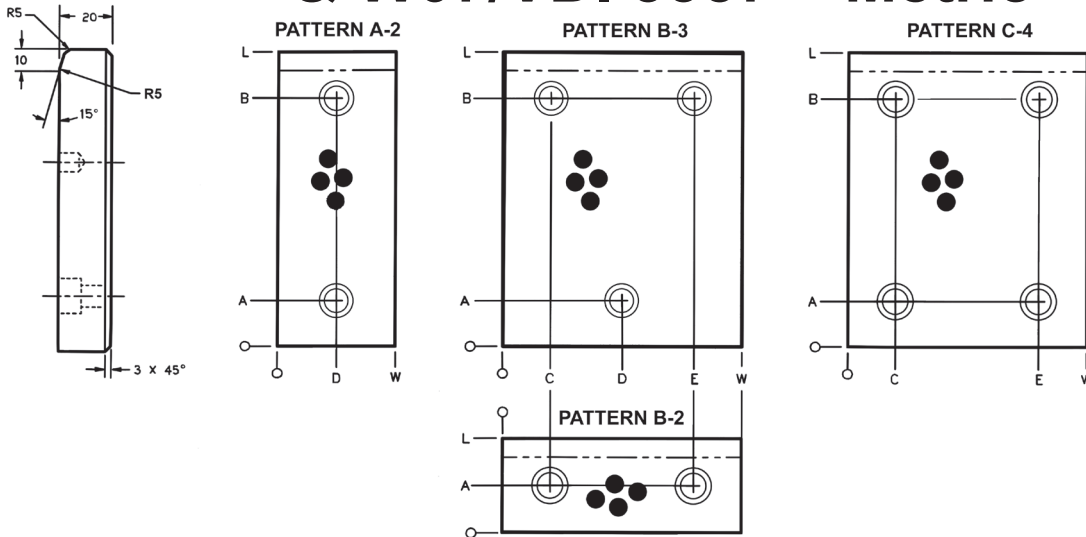

MATERIALS:

- ◆ Self-lubricating wear plates are manufactured from bronze or steel with graphite plugs. The plugs cover 20-25% of the wear surface.
- ◆ Wear plates are also available in plain steel.

TOLERANCES:

- ◆ Thickness $\pm 0.00/ -0.02$ mm
- ◆ Mounting hole locations ± 0.2 mm
- ◆ Flatness ± 0.013 mm
- ◆ Unless otherwise noted ± 0.25 mm

MOUNTING SCREWS:

- ◆ M8 S.H.C.S. for part numbers VDY050080 and VDY080050.
- ◆ M12 S.H.C.S. for all other part numbers.

ADDITIONAL AUTOMOTIVE STANDARDS

Width W (mm)	Length L (mm)	Bronze w/Graphite Plugs Part Number	Steel w/Graphite Plugs Part Number	Steel Plain Part Number	Mounting Hole Pattern & Location						
					Hole Qty.	Hole Pattern	A (mm)	B (mm)	C (mm)	D (mm)	E (mm)
100	250	WDX13-80-03100250Y*	WDX13-80-03100250G*	WDX13-80-03100250X*	2	A-2	25	225	-	50	-
	250	90.20.65-100250Y*	-	90.20.65-100250X*	4	C-4	25	225	25	-	75
	315	WDX13-80-03100315Y*	WDX13-80-03100315G*	WDX13-80-03100315X*	2	A-2	25	290	-	50	-
125	200	90.20.65-125200*	-	90.20.65-125200*	4	C-4	25	175	25	-	100
	250	WDX13-80-03125250Y*	WDX13-80-03125250G*	WDX13-80-03125250X*	3	B-3	25	225	25	62.5	100
	250	90.20.65-125250Y*	-	90.20.65-125250X*	4	C-4	25	225	25	-	100
	315	WDX13-80-03125315Y*	WDX13-80-03125315G*	WDX13-80-03125315X*	3	B-3	25	290	25	62.5	100
160	200	90.20.65-160200Y*	-	90.20.65-160200G*	4	C-4	25	175	25	-	135
	250	WDX13-80-03160250Y*	WDX13-80-03160250G*	WDX13-80-03160250X*	3	B-3	25	225	25	80	135
	250	90.20.65-160250Y*	-	90.20.65-160250X*	4	C-4	25	225	25	-	135
	300	90.20.65-160300Y*	-	90.20.65-160300X*	4	C-4	25	275	25	-	135
200	200	90.20.65-200200Y*	-	90.20.65-200200X*	4	C-4	25	175	25	-	175
	250	90.20.65-200250Y*	-	90.20.65-200250X*	4	C-4	25	225	25	-	175
	300	90.20.65-200300Y*	-	90.20.65-200300X*	4	C-4	25	275	25	-	175

PLEASE NOTE:

- ◆ These wear plates have hole patterns that differ from our standard VDI/NAAMS wear plates. They must be ordered using the GM or Ford part number to receive the correct mounting hole locations.



Automotive Wear Plate Conversions

Dimensions		Bronze with Graphite Plugs					Steel with Graphite Plugs		
Width	Length	Lamina Part #	NAAMS W07 Series #	Chrysler Part #	Ford Part #	General Motors Part #	Lamina Part #	NAAMS W05 Series #	Ford Part #
50	80	VDY050080					VDG050080		
50	100	VDY050100	W070510	19-290-3204	WDX13803050100Y	90.20.65-50100Y	VDG050100	W050510	WDX13803050100G
50	125	VDY050125	W070512	19-290-3205	WDX13803050125Y	90.20.65-50125Y	VDG050125	W050512	WDX13803050125G
50	160	VDY050160	W070516	19-290-3206	WDX13803050160Y	90.20.65-50160Y	VDG050160	W050516	WDX13803050160G
50	200	VDY050200	W070520	19-290-3208	WDX13803050200Y	90.20.65-50200Y	VDG050200	W050520	WDX13803050200G
80	50	VDY080050					VDG080050		
80	80	VDY080080					VDG080080		
80	100	VDY080100	W070810	19-290-3304	WDX13803080100Y	90.20.65-80100Y	VDG080100	W050810	WDX13803080100G
80	125	VDY080125	W070812	19-290-3305	WDX13803080125Y	90.20.65-80125Y	VDG080125	W050812	WDX13803080125G
80	160	VDY080160	W070816	19-290-3306	WDX13803080160Y	90.20.65-80160Y	VDG080160	W050816	WDX13803080160G
80	200	VDY080200	W070820	19-290-3308	WDX13803080200Y	90.20.65-80200Y	VDG080200	W050820	WDX13803080200G
80	250	VDY080250		19-290-3310			VDG080250		
80	315	VDY080315		19-290-3312			VDG080315		
100	50	VDY100050		19-290-3402		90.20.65-10050Y	VDG100050		
100	80	VDY100080	W071080	19-290-3403	WDX13803100080Y	90.20.65-10080Y	VDG100080	W051080	WDX13803100080G
100	100	VDY100100	W071010	19-290-3404	WDX13803100100Y	90.20.65-100100Y	VDG100100	W051010	WDX13803100100G
100	125	VDY100125	W071012	19-290-3405	WDX13803100125Y	90.20.65-100125Y	VDG100125	W051012	WDX13803100125G
100	160	VDY100160	W071016	19-290-3406	WDX13803100160Y	90.20.65-100160Y	VDG100160	W051016	WDX13803100160G
100	200	VDY100200	W071020	19-290-3408	WDX13803100200Y	90.20.65-100200Y	VDG100200	W051020	WDX13803100200G
100	250	VDY100250		19-290-3410	WDX13803100250Y	90.20.65-100250Y	VDG100250		WDX13803100250G
100	315	VDY100315		19-290-3412	WDX13803100315Y		VDG100315		WDX13803100315G
125	50	VDY125050					VDG125050		
125	80	VDY125080	W071208	19-290-3503	WDX13803125080Y	90.20.65-125080Y	VDG125080	W051208	WDX13803125080G
125	100	VDY125100	W071212	19-290-3504	WDX13803125100Y	90.20.65-125100Y	VDG125100	W051212	WDX13803125100G
125	125	VDY125125	W071212	19-290-3505	WDX13803125125Y	90.20.65-125125Y	VDG125125	W051212	WDX13803125125G
125	160	VDY125160	W071216	19-290-3506	WDX13803125160Y	90.20.65-125160Y	VDG125160	W051216	WDX13803125160G
125	200	VDY125200	W071220	19-290-3508	WDX13803125200Y	90.20.65-125200Y	VDG125200	W051220	WDX13803125200G
125	250	VDY125250		19-290-3510	WDX13803125250Y	90.20.65-125250Y	VDG125250		WDX13803125250G
125	315	VDY125315		19-290-3512	WDX13803125315Y		VDG125315		WDX13803125315G
160	50	VDY160050					VDG160050		
160	80	VDY160080					VDG160080		
160	100	VDY160100	W071610	19-290-3604	WDX13803160100Y	90.20.65-160100Y	VDG160100	W051610	WDX13803160100G
160	125	VDY160125	W071612	19-290-3605	WDX13803160125Y	90.20.65-160125Y	VDG160125	W051612	WDX13803160125G
160	160	VDY160160	W071616	19-290-3606	WDX13803160160Y	90.20.65-160160Y	VDG160160	W051616	WDX13803160160G
160	200	VDY160200	W071620	19-290-3608	WDX13803160200Y	90.20.65-160200Y	VDG160200		WDX13803160200G
160	250	VDY160250		19-290-3610	WDX13803160250Y	90.20.65-160250Y	VDG160250		WDX13803160250G
160	300					90.20.65-160300Y			
160	315	VDY160315		19-290-3612	WDX13803160315Y		VDG160315		WDX13803160315G
200	200					90.20.65-200300Y			
200	250					90.20.65-200250Y			
200	300					90.20.65-200300Y			

PLEASE NOTE:

- ◆ The highlighted items (in grey) have different hole patterns than our existing wear plates. They do not convert to a Lamina part number and must be ordered as highlighted.



Automotive Wear Plate Conversions

Dimensions		Plain Steel				
Width	Length	Lamina Part #	NAAMS W06 Series #	Chrysler Part #	Ford Part #	General Motors Part #
50	80	VDX050080				
50	100	VDX050100	W060510	19-290-4204	WDX13803050100X	90.20.65-50100X
50	125	VDX050125	W060512	19-290-4205	WDX13803050125X	90.20.65-50125X
50	160	VDX050160	W060516	19-290-4206	WDX13803050160X	90.20.65-50160X
50	200	VDX050200	W060520	19-290-4208	WDX13803050200X	90.20.65-50200X
80	50	VDX080050				
80	80	VDX080080				
80	100	VDX080100	W060810	19-290-4304	WDX13803080100X	90.20.65-80100X
80	125	VDX080125	W060812	19-290-4305	WDX13803080125X	90.20.65-80125X
80	160	VDX080160	W060816	19-290-4306	WDX13803080160X	90.20.65-80160X
80	200	VDX080200	W060820	19-290-4308	WDX13803080200X	90.20.65-80200X
80	250	VDX080250		19-290-4310		
80	315	VDX080315		19-290-4312		
100	50	VDX100050		19-290-4402		90.20.65-10050X
100	80	VDX100080	W061080	19-290-4403	WDX13803100080X	90.20.65-10080X
100	100	VDX100100	W061010	19-290-4404	WDX13803100100X	90.20.65-100100X
100	125	VDX100125	W061012	19-290-4405	WDX13803100125X	90.20.65-100125X
100	160	VDX100160	W061016	19-290-4406	WDX13803100160X	90.20.65-100160X
100	200	VDX100200	W061020	19-290-4408	WDX13803100200X	90.20.65-100200X
100	250	VDX100250		19-290-4410	WDX13803100250X	90.20.65-100250X
100	315	VDX100315		19-290-4412	WDX13803100315X	
125	50	VDX125050				
125	80	VDX125080	W061208	19-290-4503	WDX13803125080X	90.20.65-12580X
125	100	VDX125100	W061212	19-290-4504	WDX13803125100X	90.20.65-125100X
125	125	VDX125125	W061212	19-290-4505	WDX13803125125X	90.20.65-125125X
125	160	VDX125160	W061216	19-290-4506	WDX13803125160X	90.20.65-125160X
125	200	VDX125200	W061220	19-290-4508	WDX13803125200X	90.20.65-125200X
125	250	VDX125250		19-290-4510	WDX13803125250X	90.20.65-125250X
125	315	VDX125315		19-290-4512	WDX13803125315X	
160	50	VDX160050				
160	80	VDX160080				
160	100	VDX160100	W061610	19-290-4604	WDX13803160100X	90.20.65-160100X
160	125	VDX160125	W061612	19-290-4605	WDX13803160125X	90.20.65-160125X
160	160	VDX160160	W061616	19-290-4606	WDX13803160160X	90.20.65-160160X
160	200	VDX160200	W061620	19-290-4608	WDX13803160200X	90.20.65-160200X
160	250	VDX160250		19-290-4610	WDX13803160250X	90.20.65-160250X
160	300					90.20.65-160300X
160	315	VDX160315		19-290-4612	WDX13803160315X	
200	200					90.20.65-200300X
200	250					90.20.65-200250X
200	300					90.20.65-200300X

PLEASE NOTE:

- ◆ The highlighted items (in grey) have different hole patterns than our existing wear plates. They do not convert to a Lamina part number and must be ordered as highlighted.

Wear Plates – NAAMS Series

W01, W02 & W03 – Metric

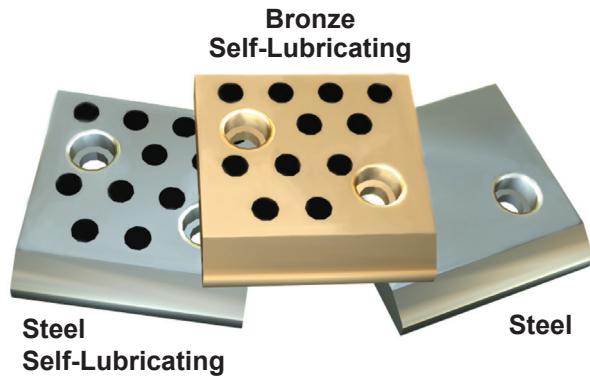

PRODUCT FEATURES

The NAAMS Series of wear plate fully meets the North American Automotive Standard. They are 20mm thick and available in plain steel, steel with graphite plugs and bronze with graphite plugs. The bronze and steel with graphite plugs are self-lubricating products and do not require lubrication during production. All NAAMS wear plates are supplied with mounting holes to accommodate M12 S.H.C.S. For ease of identification, all products are marked with the part number.

Steel Without Graphite Plugs Part #	Steel With Graphite Plugs Part #	Bronze With Graphite Plugs Part #	Width W	Length L
W025010	W015010	W035010	50	100
W025015	W015015	W035015		150
W025020	W015020	W035020		200
W028010	W018010	W038010	80	100
W028015	W018015	W038015		150
W028020	W018020	W038020		200
W028025	W018025	W038025		250
W028031	W018031	W038031		315
W021050	W011050	W031050	100	50
W021080	W011080	W031080		80
W021010	W011010	W031010		100
W021015	W011015	W031015		150
W021020	W011020	W031020		200
W021025	W011025	W031025		250
W021031	W011031	W031031		315
W021280	W011280	W031280	125	80
W021210	W011210	W031210		100
W021215	W011215	W031215		150
W021220	W011220	W031220		200
W021225	W011225	W031225		250
W021231	W011231	W031231		315
W021610	W011610	W031610	160	100
W021615	W011615	W031615		150
W021620	W011620	W031620		200
W021625	W011625	W031625		250
W021631	W011631	W031631		315

Wear Plates – NAAMS Series

W01, W02 & W03 – Metric

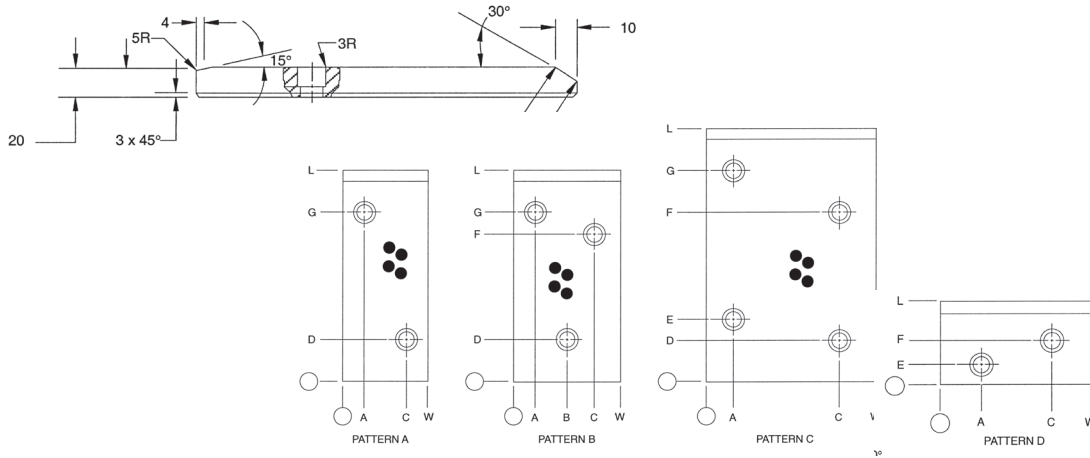

MATERIALS:

- ◆ Steel wear plates are manufactured from high quality carburized steel. They are precision ground and hardened to Rc 56-60 (1.2 mm to 1.5 mm deep). They are available with or without graphite plugs.
- ◆ Bronze wear plates are manufactured from bronze material with oil impregnated graphite plugs.
- ◆ When ordered with graphite plugs, the plugs cover 25-30% of the wear surface and are arranged to generate optimal coverage at any engagement direction of the wear plate.

TOLERANCES:

- ◆ Thickness ± 0.025 mm
- ◆ Mounting hole locations ± 0.25 mm
- ◆ Flatness ± 0.012 mm
- ◆ Unless otherwise noted ± 0.25 mm

MOUNTING SCREWS:

- ◆ M12 S.H.C.S. recommended. Plate has 13.5mm through hole with 20mm counter-bore 13mm deep.

Width W (mm)	Length L (mm)	Mounting Hole Pattern & Location								
		Hole Qty.	Pattern	A (mm)	B (mm)	C (mm)	D (mm)	E (mm)	F (mm)	G (mm)
50	100	2	A	25	–	25	30	–	–	60
	150	2	A		–		30	–	–	110
	200	2	A		–		40	–	–	160
80	100	2	A	20	–	60	30	–	–	60
	150	2	A		–		30	–	–	110
	200	2	A		–		40	–	–	160
	250	2	A		–		40	–	–	210
	315	3	B		40		–	250	275	
100	50	2	D	22	–	78	–	14	27	–
	80	2	D		–		30	50	–	
	100	2	A		–		30	–	–	60
	150	2	A		–		30	–	–	110
	200	3	B		50		40	–	135	160
	250	3	B		50		40	–	185	210
	315	3	B		50		40	–	250	275
125	80	2	D	25	–	100	–	30	50	–
	100	2	A		–		30	–	–	60
	150	2	A		–		30	–	–	110
	200	3	B		62		40	–	135	160
	250	3	B		62		40	–	185	210
	315	4	C		–		40	65	250	275
160	100	2	A	30	–	130	30	–	–	60
	150	2	A		–		30	–	–	110
	200	3	B		80		40	–	135	160
	250	4	C		–		40	65	185	210
	315	4	C		–		40	65	250	275

Wear Plates – Automotive – Inch

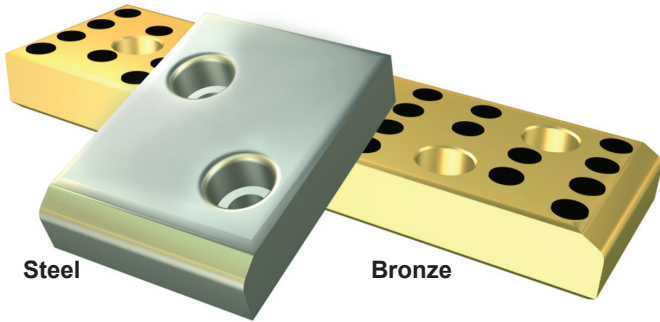

- Steel
- Bronze Self-Lubricating

AVAILABLE FROM STOCK

Lamina offers a range of wear plate styles and sizes for your selection.

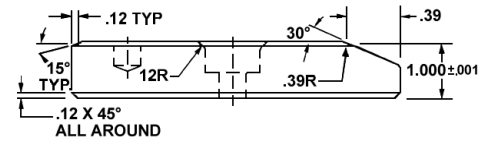

WEAR PLATES – INCH													
NSX	NYG	NOSE WIDTH	LENGTH	SCREW HOLES		SCREW HOLE LOCATIONS							
				NO.	PAT.	A	B	C	D	E	F	G	H
STEEL	BRONZE GRAPHITE	W											
NSX82508	NYG82508	2.50	8.00	2	A	1.25	-	1.25	1.50	6.50	-	-	-
NSX83025	NYG83025	3.00	2.50	2	A	.75	-	2.25	1.25	-	-	-	-
NSX8304	NYG8304	3.00	4.00	2	A	.75	-	2.25	1.25	2.75	-	-	-
NSX8305	NYG8305	3.00	5.00	2	A	.75	-	2.25	1.50	3.75	-	-	-
NSX8306	NYG8306	3.00	6.00	2	A	.75	-	2.25	1.50	4.50	-	-	-
NSX8308	NYG8308	3.00	8.00	2	A	.75	-	2.25	1.50	6.50	-	-	-
NSX8310	NYG8310	3.00	10.00	3	B	.75	1.50	2.25	1.50	2.50	8.50	-	-
NSX8312	NYG8312	3.00	12.00	3	B	.75	1.50	2.25	1.50	2.50	10.50	-	-
NSX84025	NYG84025	4.00	2.50	2	A	1.25	-	2.75	1.25	-	-	-	-
NSX8403	NYG8403	4.00	3.00	2	A	1.00	-	3.00	1.50	2.25	-	-	-
NSX8404	NYG8404	4.00	4.00	2	A	1.00	-	3.00	1.25	2.75	-	-	-
NSX8405	NYG8405	4.00	5.00	2	A	.88	-	3.12	1.50	3.75	-	-	-
NSX8406	NYG8406	4.00	6.00	2	A	.88	-	3.12	1.50	4.50	-	-	-
NSX8408	NYG8408	4.00	8.00	3	B	.88	2.00	3.12	1.50	2.50	6.50	-	-
NSX8410	NYG8410	4.00	10.00	3	B	.88	2.00	3.12	1.50	2.50	8.50	-	-
NSX8412	NYG8412	4.00	12.00	3	B	.88	2.00	3.12	1.50	2.50	10.50	-	-
NSX85025	NYG85025	5.00	2.50	2	A	1.25	-	3.75	1.25	-	-	-	-
NSX8504	NYG8504	5.00	4.00	2	A	1.00	-	4.00	1.50	2.75	-	-	-
NSX8505	NYG8505	5.00	5.00	2	A	1.00	-	4.00	1.50	3.75	-	-	-
NSX8506	NYG8506	5.00	6.00	2	A	1.00	-	4.00	1.50	4.50	-	-	-
NSX8508	NYG8508	5.00	8.00	3	B	1.00	2.50	4.00	1.50	2.50	6.50	-	-
NSX8510	NYG8510	5.00	10.00	3	B	1.00	2.50	4.00	1.50	2.50	8.50	-	-
NSX8512	NYG8512	5.00	12.00	4	C	1.00	-	4.00	1.50	2.50	-	9.50	10.50
NSX8604	NYG8604	6.00	4.00	3	B	1.00	3.00	5.00	1.25	2.25	2.75	-	-
NSX8605	NYG8605	6.00	5.00	2	A	1.12	-	4.88	1.50	3.75	-	-	-
NSX8606	NYG8606	6.00	6.00	4	C	1.00	-	5.00	1.25	2.25	-	3.75	4.75
NSX8608	NYG8608	6.00	8.00	4	C	1.00	-	5.00	1.25	2.25	-	5.75	6.75
NSX8610	NYG8610	6.00	10.00	5	D	1.00	3.00	5.00	1.25	2.25	5.00	7.75	8.75
NSX8612	NYG8612	6.00	12.00	5	D	1.00	3.00	5.00	1.25	2.25	6.00	9.75	10.75
NSX8805	NYG8805	8.00	5.00	2	A	1.25	-	6.75	1.50	3.75	-	-	-
NSX8806	NYG8806	8.00	6.00	4	C	1.00	-	7.00	1.25	2.25	-	3.75	4.75

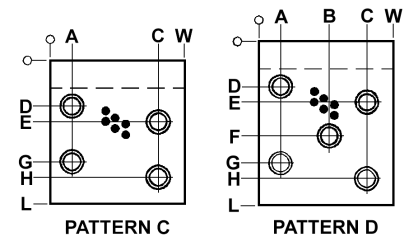
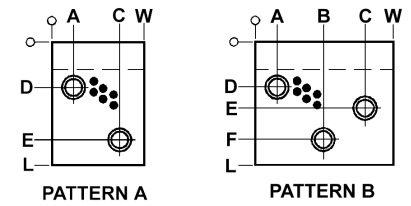

NOTES & SPECIFICATIONS

- ◆ All dimensions are $\pm .010$ unless noted.
- ◆ All screw holes are for 1/2 Soc. Hd. Scr., 9/16 drill through & 13/16 Counterbore x .56 deep.

TOLERANCES:

- Thickness $\pm .001$
- Hole Location $\pm .010$
- Flatness $\pm .0005$

(Do not use grease on graphite-plugged surfaces.)

Corner Guide Blocks

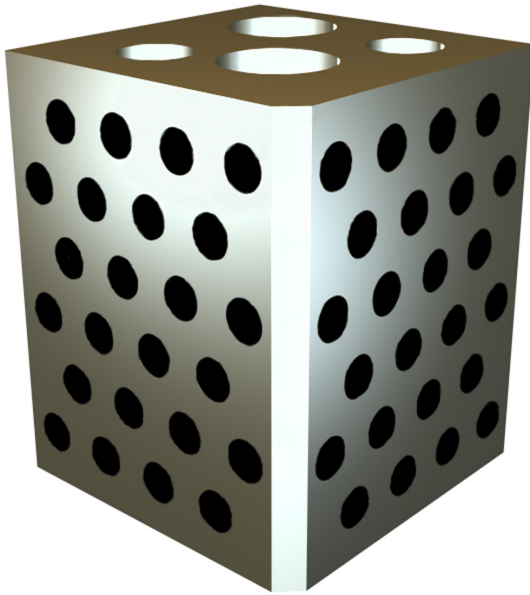

- Solid Steel
- Self-Lubricating

AVAILABLE FROM STOCK

AUTOMOTIVE METRIC
NAAMS STANDARD

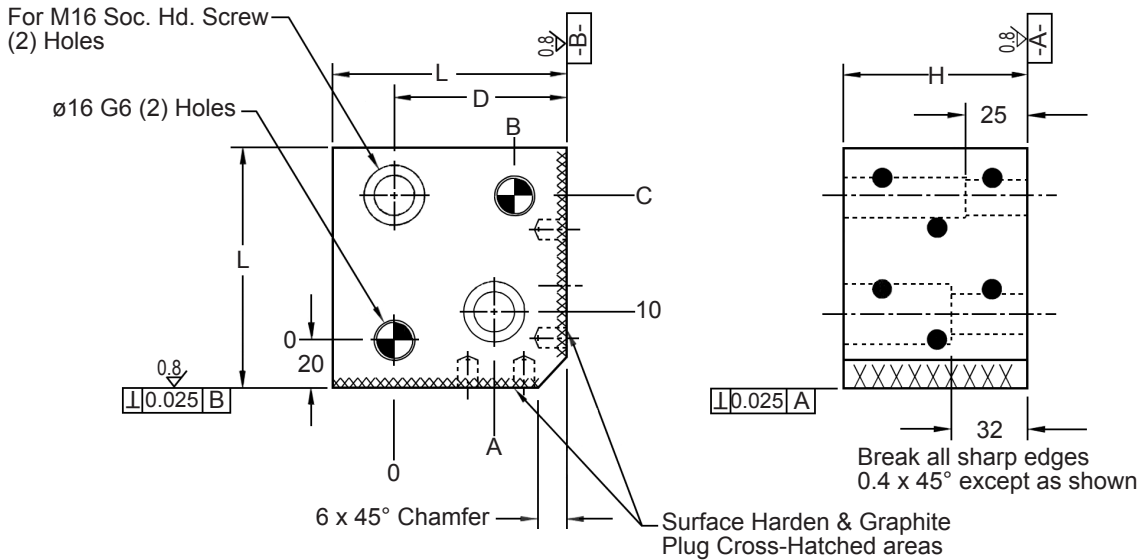

NOTES & SPECIFICATIONS

- ◆ Screw hole locations ±0.25
- ◆ Dowel hole locations ±0.10

Apply a film or mist of light machine oil on new self-lubricating parts before use will enhance the self-lubricating properties.

(Do not use grease on graphite-plugged surfaces.)

CORNER GUIDE BLOCKS – METRIC						
PART NUMBER	H	A	B	C	D	L
		±0.25	±0.013	±0.013	±0.25	
G118007	75					
G118010	100	25	35	40	55	80
G118012	125					
G119507	75					
G119510	100	40	50	55	70	95
G119512	125					
G111207	75					
G111210	100	65	75	80	95	120
G111212	125					

Guide Blocks – Inch

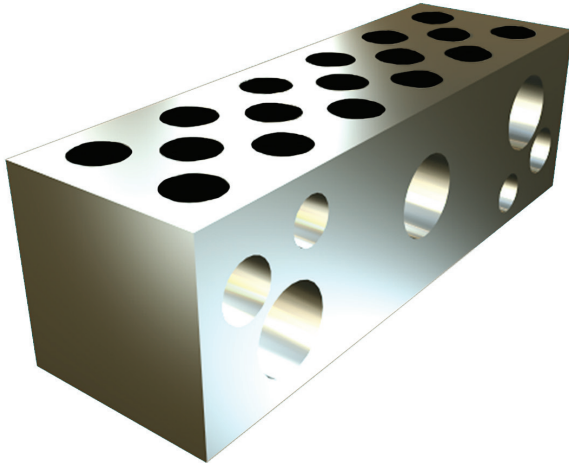

- Solid Steel
- Chromium Steel AISI-4150 or 6150
- Wear area is surface hardened – RC 56-62
- All Blocks are self-lubricating with graphite oil plugs
- All Blocks are precision ground
- All Tolerances not noted are held to ± 0.010 and are non-cumulative
- Easily altered if necessary
- Lamina logo and part number is etched/stamped on part

GUIDE BLOCKS – INCH							
PART NUMBER	WIDTH 1.875		A	B	C	D	# MTG. HOLES
	LENGTH	HEIGHT	+0.000 –0.005				
L14G24G	3.00	1.69	-	-	2.000	2.000	2
L14G32G	4.00		-	-	3.000	3.000	
L14G40G	5.00		-	2.500	4.000	4.000	3
L14G48G	6.00		-	3.000	5.000	5.000	
L14G64G	8.00		2.380	5.620	7.000	7.000	4
L14G80G	10.00		3.500	6.500	9.000	9.000	
L16G24G	3.00	1.94	-	-	2.000	2.000	2
L16G32G	4.00		-	-	3.000	3.000	
L16G40G	5.00		-	2.500	4.000	4.000	3
L16G48G	6.00		-	3.000	5.000	5.000	
L16G64G	8.00		2.380	5.620	7.000	7.000	4
L16G80G	10.00		3.500	6.500	9.000	9.000	
L20G24G	3.00	2.44	-	-	2.000	2.000	2
L20G32G	4.00		-	-	3.000	3.000	
L20G40G	5.00		-	2.500	4.000	4.000	3
L20G48G	6.00		-	3.000	5.000	5.000	
L20G64G	8.00		2.380	5.620	7.000	7.000	4
L20G80G	10.00		3.500	6.500	9.000	9.000	
L24G24G	3.00	2.94	-	-	2.000	2.000	2
L24G32G	4.00		-	-	3.000	3.000	
L24G40G	5.00		-	2.500	4.000	4.000	3
L24G48G	6.00		-	3.000	5.000	5.000	
L24G64G	8.00		2.380	5.620	7.000	7.000	4
L24G80G	10.00		3.500	6.500	9.000	9.000	

Location of mounting holes and dowels are tightly held to provide for interchangeability.

Apply a film or mist of light machine oil on new self-lubricating parts before use will enhance the self-lubricating properties.

(Do not use grease on graphite-plugged surfaces.)

Guide Blocks – Inch, continued

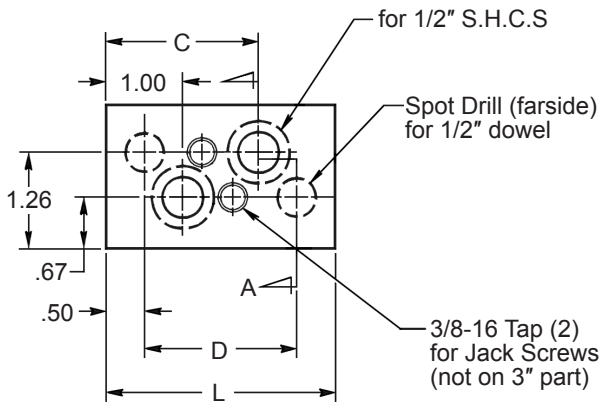

Note: Mounting Hole locations $\pm .005$

2-HOLE PATTERN

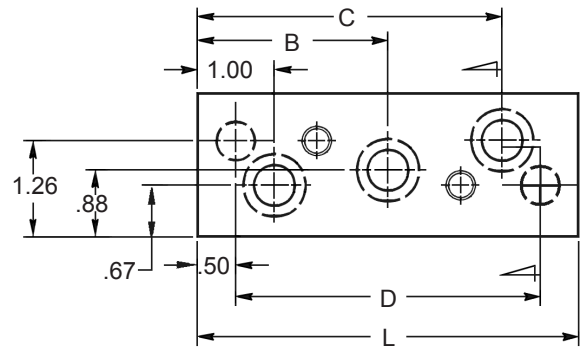

3-HOLE PATTERN

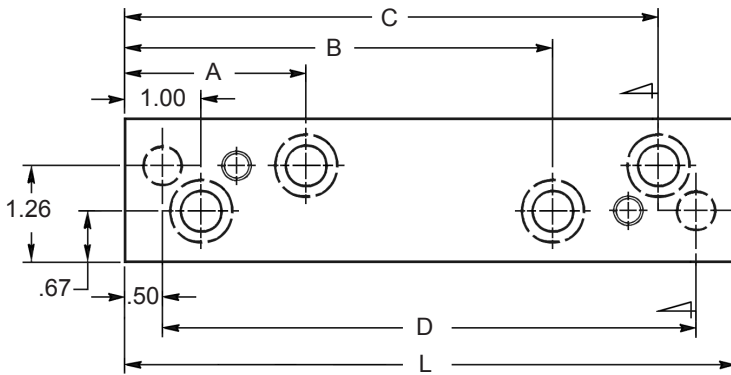

4-HOLE PATTERN

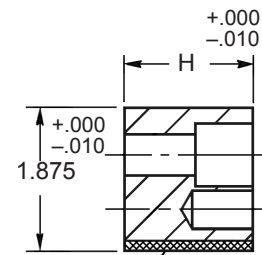

This surface is hardened and has self-lubricating graphite plugs

TYPICAL SECTION

Guide and Keeper Blocks are used together for guidance and alignment.

Keeper Block information starts on page 32.

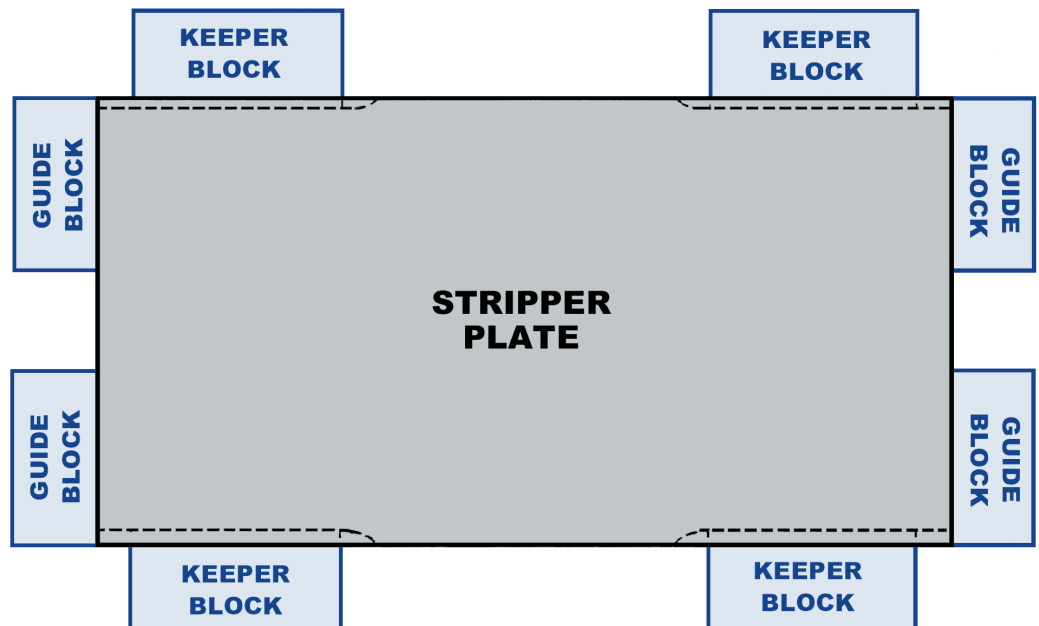

Guide Blocks – Metric – 45mm Wide

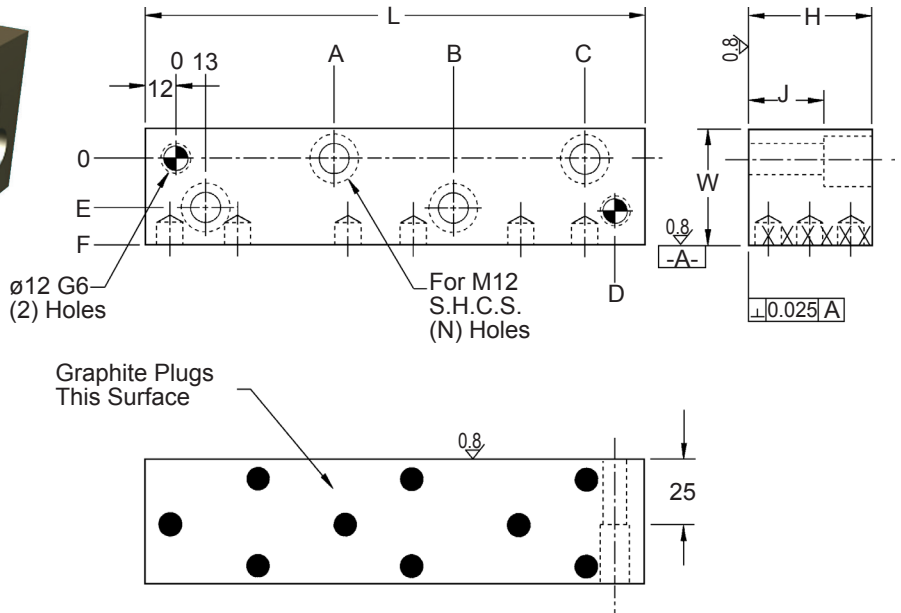
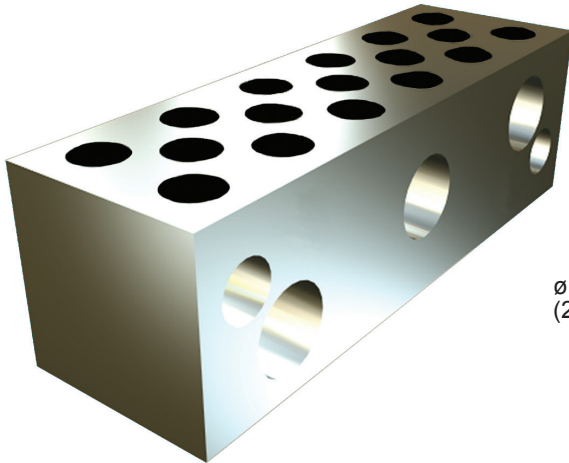

NOTES & SPECIFICATIONS:

- ◆ Screw hole locations ± 0.25
- ◆ Dowel hole locations ± 0.10
- ◆ Material: Steel
- ◆ Cross-hatched areas surface hardened

AUTOMOTIVE METRIC
NAAMS STANDARD

GUIDE BLOCKS – SOLID STEEL – SELF-LUBRICATING – 45mm																							
PART NUMBER	(N) HOLES	L	A	B	C	D	E	F	H	J	W	PART NUMBER	(N) HOLES	L	A	B	C	D	E	F	H	J	W
G014007	2	75	-	-	38	51	18	33	40	15	45	G016007	2	75	-	-	38	51	18	33	60	30	45
G014010	2	100	-	-	63	76						G016010	2	100	-	-	63	76					
G014012	3	125	-	50.5	88	101						G016012	3	125	-	50.5	88	101					
G014015	3	150	-	63.0	113	126						G016015	3	150	-	63.0	113	126					
G014017	3	175	-	75.5	138	151						G016017	3	175	-	75.5	138	151					
G014020	4	200	63	113.0	163	176						G016020	4	200	63	113.0	163	176					
G014022	4	225	73	128.0	188	201						G016022	4	225	73	128.0	188	201					
G014025	4	250	83	153.0	213	226						G016025	4	250	83	153.0	213	226					
G014507	2	75	-	-	38	51						G017507	2	75	-	-	38	51					
G014510	2	100	-	-	63	76						G017510	2	100	-	-	63	76					
G014512	3	125	-	50.5	88	101	G017512	3	125	-	50.5	88	101										
G014515	3	150	-	63.0	113	126	G017515	3	150	-	63.0	113	126										
G014517	3	175	-	75.5	138	151	G017517	3	175	-	75.5	138	151										
G014520	4	200	63	113.0	163	176	G017520	4	200	63	113.0	163	176										
G014522	4	225	73	128.0	188	201	G017522	4	225	73	128.0	188	201										
G014525	4	250	83	153.0	213	226	G017525	4	250	83	153.0	213	226										
G015007	2	75	-	-	38	51	18	33	50	30	45	<p>Applying a film or mist of light machine oil on new self-lubricating parts before use will enhance the self-lubricating properties.</p> <p>(Do not use grease on graphite-plugged surfaces.)</p>											
G015010	2	100	-	-	63	76																	
G015012	3	125	-	50.5	88	101																	
G015015	3	150	-	63.0	113	126																	
G015017	3	175	-	75.5	138	151																	
G015020	4	200	63	113.0	163	176																	
G015022	4	225	73	128.0	188	201																	
G015025	4	250	83	153.0	213	226																	

Guide Blocks – Metric – 60mm Wide

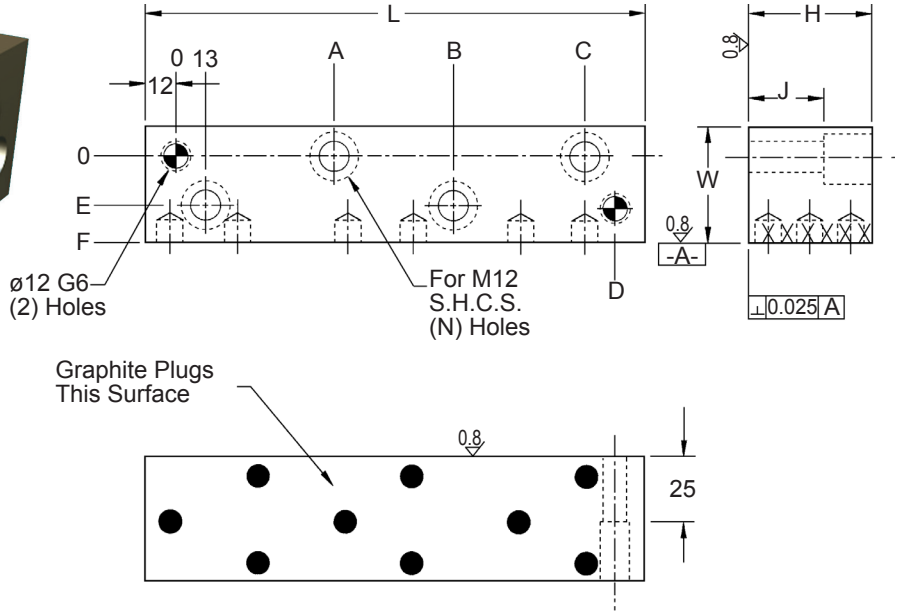
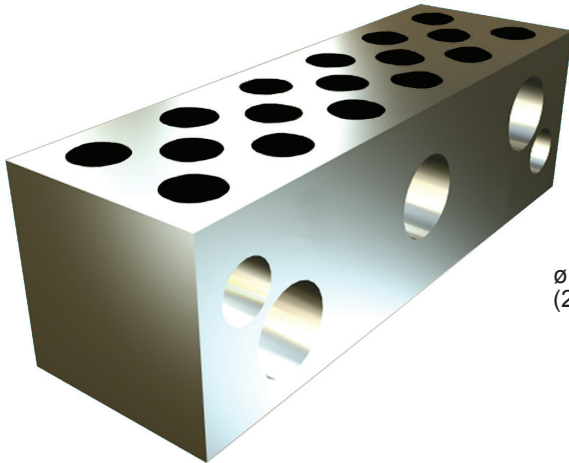

NOTES & SPECIFICATIONS:

- ◆ Screw hole locations ± 0.25
- ◆ Dowel hole locations ± 0.10
- ◆ Material: Steel
- ◆ Cross-hatched areas surface hardened

AUTOMOTIVE METRIC
NAAMS STANDARD

GUIDE BLOCKS – SOLID STEEL – SELF-LUBRICATING – 60mm																																	
PART NUMBER	(N) HOLES	L	A	B	C	D	E	F	H	J	W	PART NUMBER	(N) HOLES	L	A	B	C	D	E	F	H	J	W										
G025007	2	75	-	-	38	51	33	48	50	30	60	G028007	2	75	-	-	38	51	33	48	80	30	60										
G025010	2	100	-	-	63	76						G028010	2	100	-	-	63	76															
G025012	3	125	-	50.5	88	101						G028012	3	125	-	50.5	88	101															
G025015	3	150	-	63.0	113	126						G028015	3	150	-	63.0	113	126															
G025017	3	175	-	75.5	138	151						G028017	3	175	-	75.5	138	151															
G025020	4	200	63	113.0	163	176						G028020	4	200	200	113.0	163	176															
G025022	4	225	73	128.0	188	201						G028022	4	225	225	128.0	188	201															
G025025	4	250	83	153.0	213	226						G025025	4	250	250	153.0	213	226															
G026007	2	75	-	-	38	51						33	48	60	30	60	G020007	2						75	-	-	38	51	33	48	100	30	60
G026010	2	100	-	-	63	76											G020010	2						100	-	-	63	76					
G026012	3	125	-	50.5	88	101	G020012	3	125	-	50.5						88	101															
G026015	3	150	-	63.0	113	126	G020015	3	150	-	63.0						113	126															
G026017	3	175	-	75.5	138	151	G020017	3	175	-	75.5						138	151															
G026020	4	200	63	113.0	163	176	G020020	4	200	200	113.0						163	176															
G026022	4	225	73	128.0	188	201	G020022	4	225	225	128.0						188	201															
G026025	4	250	83	153.0	213	226	G020025	4	250	250	153.0						213	226															

Please check our website – www.daytonlamina.com – for the latest technical information.

Keeper Blocks – Light-Duty

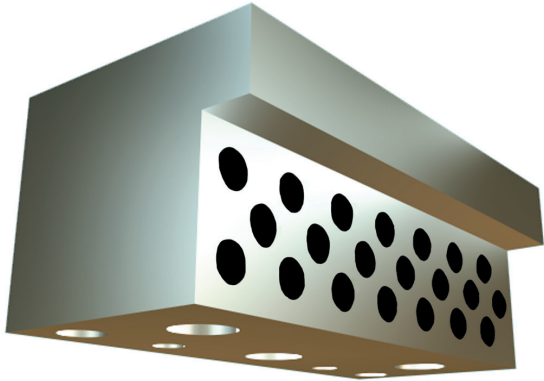

- Solid Steel
- Chromium Steel AISI-4150 or 6150
- Wear area is surface hardened – RC 56-62
- All Blocks are self-lubricating with graphite oil plugs
- All Blocks are precision ground
- All Tolerances not noted are held to ± 0.010 and are non-cumulative
- Easily altered if necessary
- Lamina logo and part number is etched/stamped on part

Apply a film or mist of light machine oil on new self-lubricating parts before use will enhance the self-lubricating properties.

(Do not use grease on graphite-plugged surfaces.)

GENERAL DIMENSIONS				
L	C	D	E	F
	± 0.005			
3.00	2.000	2.500	-	-
4.00	3.000	3.500	-	-
5.00	2.500	4.000	4.500	-
6.00	3.000	5.000	5.500	-
8.00	2.380	5.620	7.000	7.500
10.00	3.500	6.500	9.000	9.500

KEEPER BLOCKS – LIGHT DUTY – SOLID STEEL – SELF-LUBRICATING											
PART NUMBER	L	H	J	K	# MTG. HOLES	PART NUMBER	L	H	J	K	# MTG. HOLES
		± 0.005	± 0.001					± 0.005	± 0.001		
L8K24G	3.00	1.44	1.000	0.75	2	L12K24G	3.00	1.94	1.500	1.00	2
L8K32G	4.00				2	L12K32G	4.00				2
L8K40G	5.00				3	L12K40G	5.00				3
L8K48G	6.00				3	L12K48G	6.00				3
L8K64G	8.00				4	L12K64G	8.00				4
L8K80G	10.00				4	L12K80G	10.00				4
L10K24G	3.00	1.69	1.250	1.00	2	L14K24G	3.00	2.44	1.750	1.25	2
L10K32G	4.00				2	L14K32G	4.00				2
L10K40G	5.00				3	L14K40G	5.00				3
L10K48G	6.00				3	L14K48G	6.00				3
L10K64G	8.00				4	L14K64G	8.00				4
L10K80G	10.00				4	L14K80G	10.00				4

Keeper Blocks – Light-Duty, continued

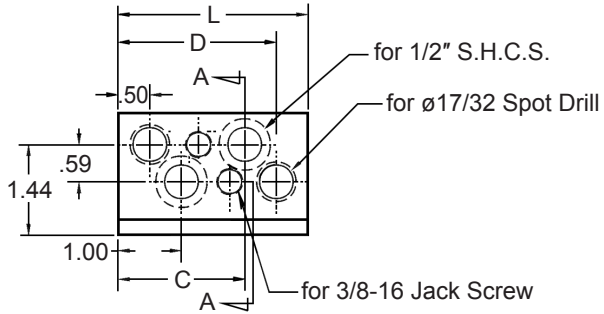

FOR 3 AND 4 INCH LENGTHS

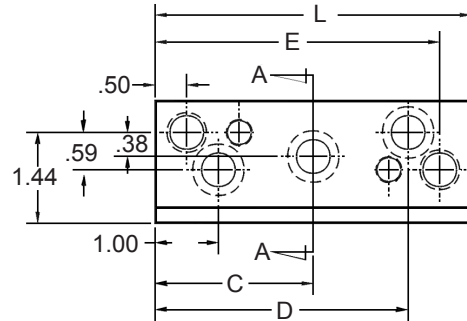

FOR 5 AND 6 INCH LENGTHS

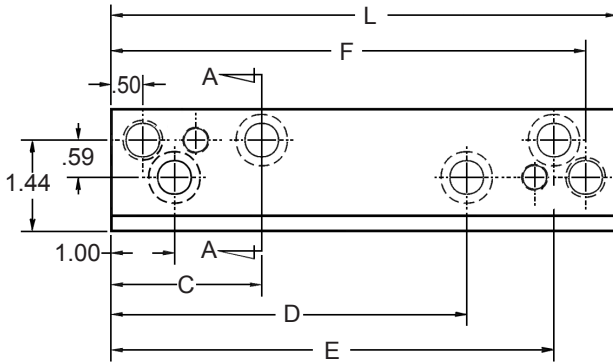

FOR 8 TO 10 INCH LENGTHS

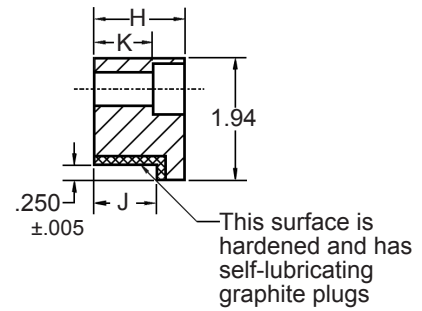

TYPICAL SECTION A-A

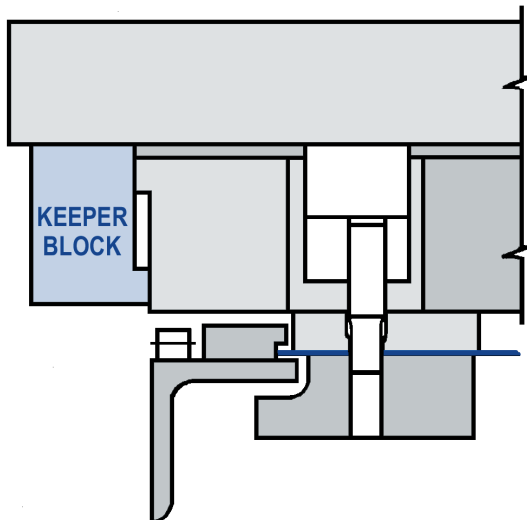

Keeper Block as Side Guide

Keeper Blocks – Medium-Duty

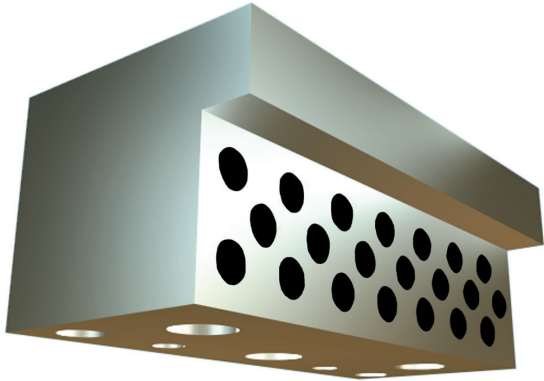

- Solid Steel
- Chromium Steel AISI-4150 or 6150
- Wear area is surface hardened – RC 56-62
- All Blocks are self-lubricating with graphite oil plugs
- All Blocks are precision ground
- All Tolerances not noted are held to ± 0.010 and are non-cumulative
- Easily altered if necessary
- Lamina logo and part number is etched/stamped on part

Apply a film or mist of light machine oil on new self-lubricating parts before use will enhance the self-lubricating properties.

(Do not use grease on graphite-plugged surfaces.)

GENERAL DIMENSIONS					
L	C	D	E	F	G
	± 0.005				
3.00	2.380	2.500	-	-	-
4.00	2.120	3.380	3.500	-	-
5.00	2.120	4.380	4.500	-	-
6.00	2.120	5.380	5.500	-	-
8.00	2.120	5.880	7.380	7.500	-
10.00	2.120	5.380	7.880	9.380	9.500

KEEPER BLOCKS – MEDIUM DUTY – SOLID STEEL – SELF-LUBRICATING – INCH											
PART NUMBER	L	H	J	K	# MTG. HOLES	PART NUMBER	L	H	J	K	# MTG. HOLES
		± 0.005	± 0.001					± 0.005	± 0.001		
L8KM24G	3.00	1.62	1.000	1.00	2	L16KM24G	3.00	2.69	2.000	1.75	2
L8KM32G	4.00				3	L16KM32G	4.00				3
L8KM40G	5.00				3	L16KM40G	5.00				3
L8KM48G	6.00				3	L16KM48G	6.00				3
L8KM64G	8.00				4	L16KM64G	8.00				4
L8KM80G	10.00				5	L16KM80G	10.00				5
L10KM24G	3.00	1.88	1.250	1.25	2	L18KM24G	3.00	2.88	2.250	1.75	2
L10KM32G	4.00				3	L18KM32G	4.00				3
L10KM40G	5.00				3	L18KM40G	5.00				3
L10KM48G	6.00				3	L18KM48G	6.00				3
L10KM64G	8.00				4	L18KM64G	8.00				4
L10KM80G	10.00				5	L18KM80G	10.00				5
L12KM24G	3.00	2.12	1.500	1.50	2	L20KM24G	3.00	3.25	2.500	1.75	2
L12KM32G	4.00				3	L20KM32G	4.00				3
L12KM40G	5.00				3	L20KM40G	5.00				3
L12KM48G	6.00				3	L20KM48G	6.00				3
L12KM64G	8.00				4	L20KM64G	8.00				4
L12KM80G	10.00				5	L20KM80G	10.00				5
L14KM24G	3.00	2.44	1.750	1.75	2	L22KM24G	3.00	3.38	2.750	1.63	2
L14KM32G	4.00				3	L22KM32G	4.00				3
L14KM40G	5.00				3	L22KM40G	5.00				3
L14KM48G	6.00				3	L22KM48G	6.00				3
L14KM64G	8.00				4	L22KM64G	8.00				4
L14KM80G	10.00				5	L22KM80G	10.00				5

Keeper Blocks – Medium-Duty, continued

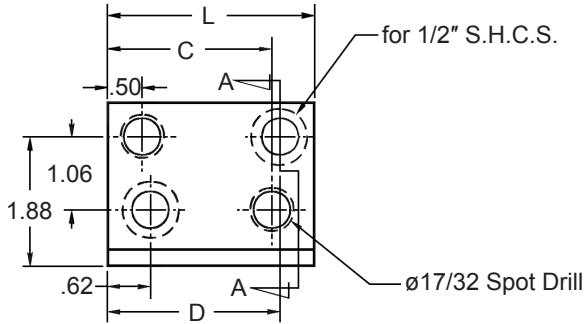

For 3 Inch Length

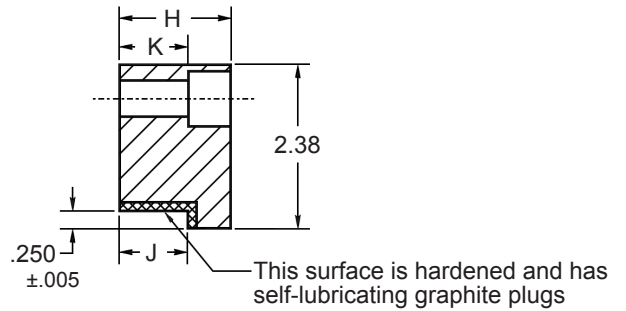

Typical Section A-A

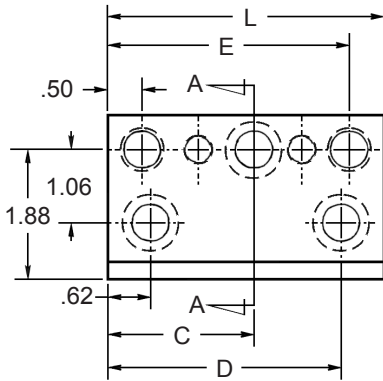

For 4 to 6 Inch Length

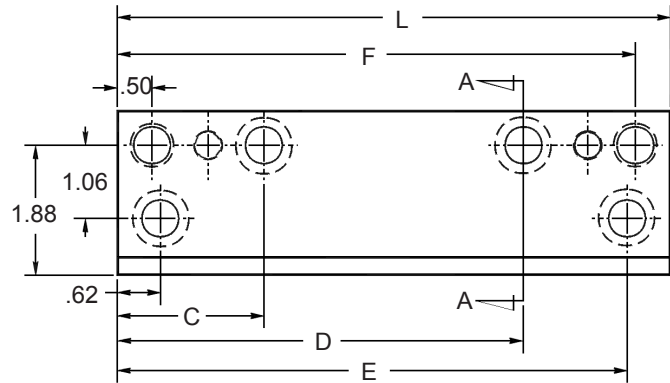

For 8 Inch Length

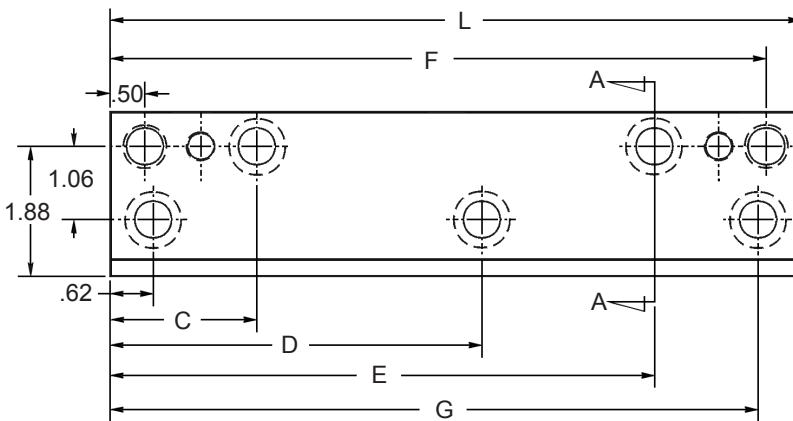

For 10 Inch Length

Keeper Blocks – Heavy-Duty

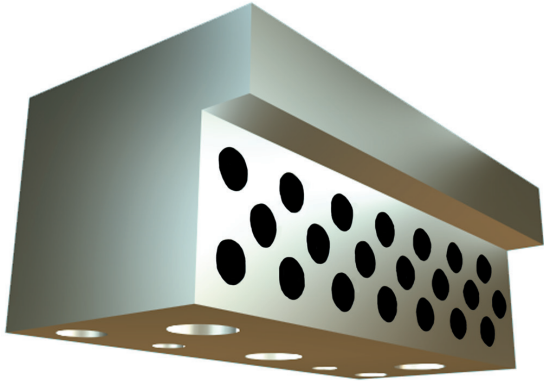

- Solid Steel
- Chromium Steel AISI-4150 or 6150
- Wear area is surface hardened – RC 56-62
- All Blocks are self-lubricating with graphite oil plugs
- All Blocks are precision ground
- All Tolerances not noted are held to ± 0.010 and are non-cumulative
- Easily altered if necessary
- Lamina logo and part number is etched/stamped on part

Apply a film or mist of light machine oil on new self-lubricating parts before use will enhance the self-lubricating properties.

(Do not use grease on graphite-plugged surfaces.)

GENERAL DIMENSIONS				
L	D	E	F	G
	± 0.005			
4.00	3.250	3.380	-	-
5.00	4.250	4.380	-	-
6.00	5.250	5.380	-	-
8.00	5.750	7.250	7.380	-
10.00	5.250	7.750	9.250	9.380
12.00	5.750	9.750	11.250	11.380

KEEPER BLOCKS – HEAVY DUTY – SOLID STEEL – SELF-LUBRICATING – INCH											
PART NUMBER	L	H	J	K	# MTG. HOLES	PART NUMBER	L	H	J	K	# MTG. HOLES
		± 0.005	± 0.001					± 0.005	± 0.001		
L14KH32G	4.00	2.62	1.750	1.50	3	L20KH32G	4.00	3.38	2.500	1.75	3
L14KH40G	5.00				3	L20KH40G	5.00				3
L14KH48G	6.00				3	L20KH48G	6.00				3
L14KH64G	8.00				4	L20KH64G	8.00				4
L14KH80G	10.00				5	L20KH80G	10.00				5
L14KH96G	12.00				5	L20KH96G	12.00				5
L16KH32G	4.00	2.88	2.000	1.50	3	L22KH32G	4.00	3.62	2.750	2.25	3
L16KH40G	5.00				3	L22KH40G	5.00				3
L16KH48G	6.00				3	L22KH48G	6.00				3
L16KH64G	8.00				4	L22KH64G	8.00				4
L16KH80G	10.00				5	L22KH80G	10.00				5
L16KH96G	12.00				5	L22KH96G	12.00				5
L18KH32G	4.00	3.12	2.250	1.50	3	L24KH32G	4.00	3.88	3.000	2.25	3
L18KH40G	5.00				3	L24KH40G	5.00				3
L18KH48G	6.00				3	L24KH48G	6.00				3
L18KH64G	8.00				4	L24KH64G	8.00				4
L18KH80G	10.00				5	L24KH80G	10.00				5
L18KH96G	12.00				5	L24KH96G	12.00				5

Keeper Blocks – Heavy-Duty, continued

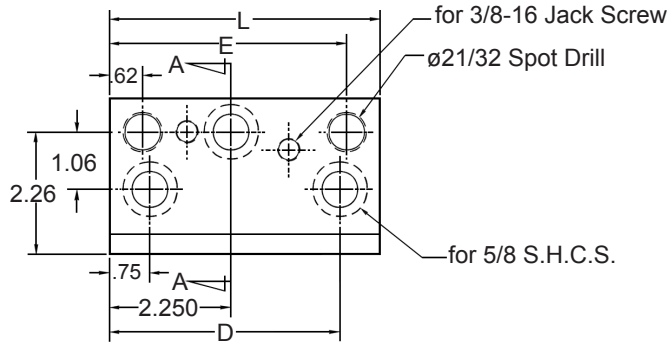

For 4 to 6 Inch Length

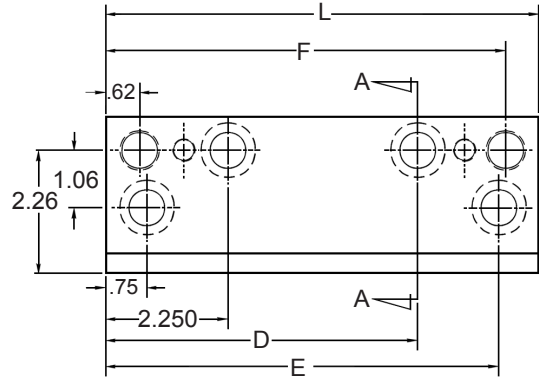

For 8 Inch Length

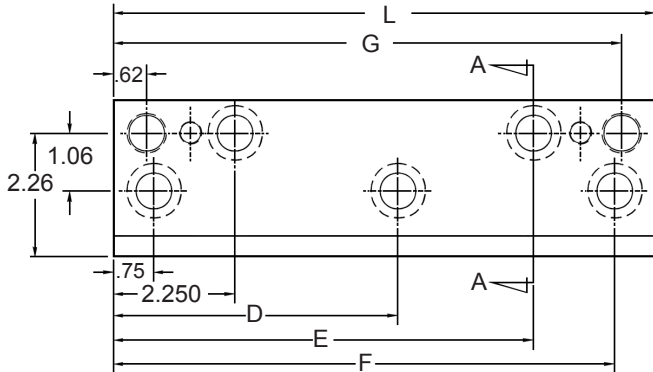

For 10 & 12 Inch Length

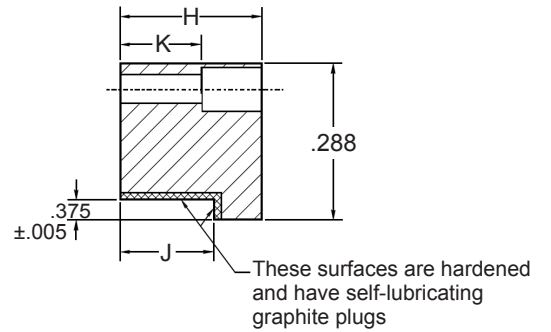

Typical Section A-A

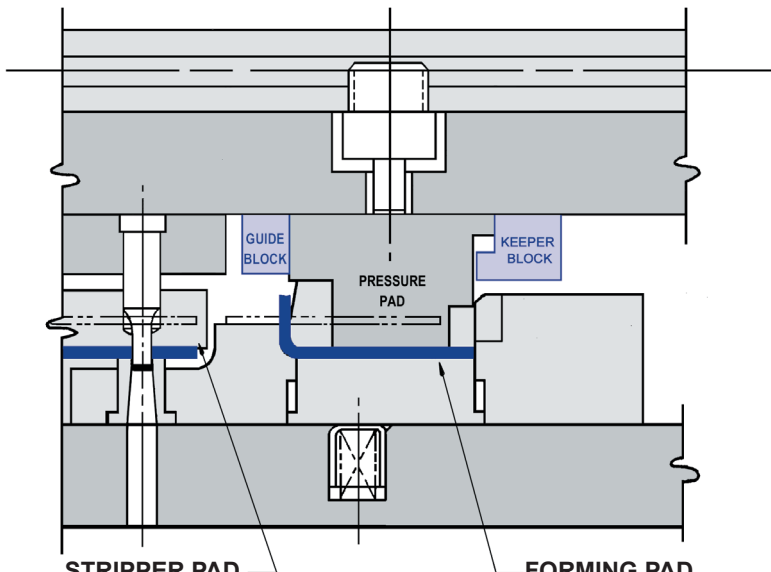

Keeper Blocks help keep the load aligned for a smooth running die operation.

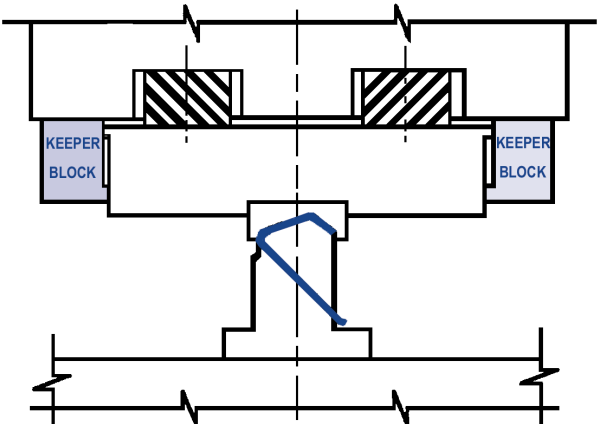

Keeper Blocks – 6mm

*AUTOMOTIVE METRIC
NAAMS STANDARD*

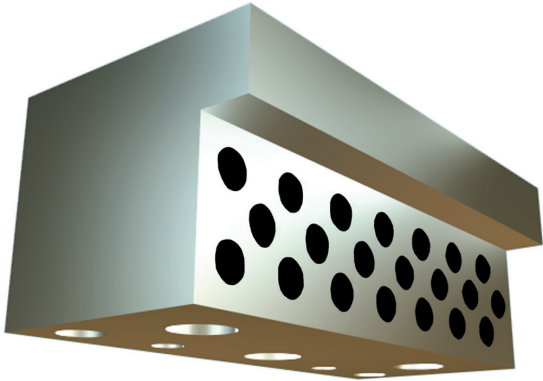

- Solid Steel
- Chromium Steel AISI-4150 or 6150
- Wear area is surface hardened – RC 56-62
- All Blocks are self-lubricating with graphite oil plugs
- All Blocks are precision ground
- All Tolerances not noted are held to ± 0.010 and are non-cumulative
- Easily altered if necessary
- Lamina logo and part number is etched/stamped on part

NOTES & SPECIFICATIONS:

- ◆ Screw hole locations ± 0.25
- ◆ Dowel hole locations ± 0.10
- ◆ Material: Steel
- ◆ Cross-hatched areas surface hardened

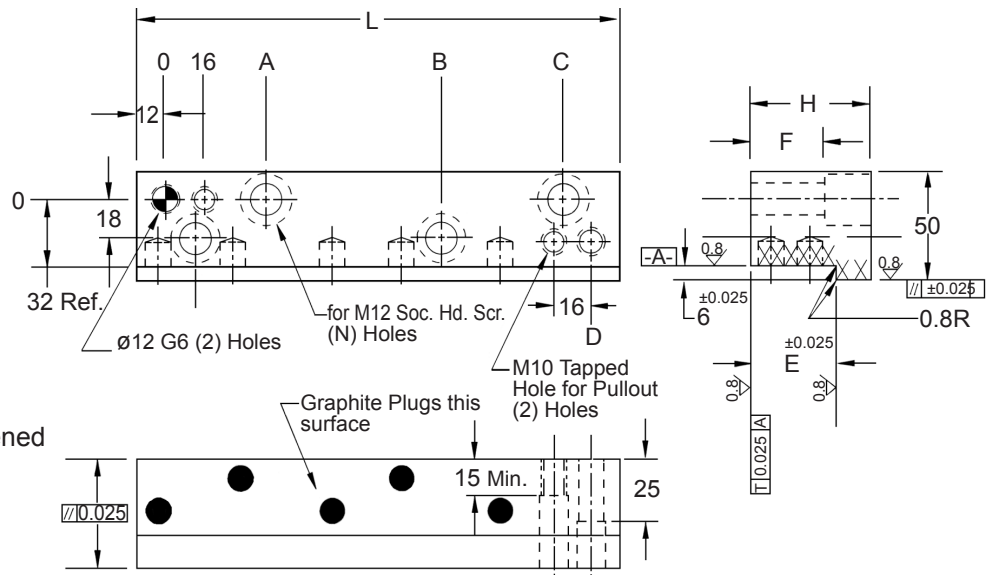

KEEPER BLOCKS – SOLID-STEEL – SELF-LUBRICATING – 6mm									
PART NUMBER	(N) HOLES	L	A	B	C	D	E	F	H
			± 0.25				± 0.025		
R012507	2	75	-	-	38	51	25	15	37
R012510	2	100	-	-	63	76			
R012515	3	150	-	63	113	126			
R012520	4	200	63	113	163	176			
R013207	2	75	-	-	38	51	32	15	45
R013210	2	100	-	-	63	76			
R013215	3	150	-	63	113	126			
R013220	4	200	63	113	163	176			
R013707	2	75	-	-	38	51	37	30	50
R013710	2	100	-	-	63	76			
R013715	3	150	-	63	113	126			
R013720	4	200	63	113	163	176			
R014810	2	100	-	-	63	76	48	30	60
R014815	3	100	-	63	113	126			
R014820	4	150	63	113	163	176			
R014825	4	200	63	113	213	226			

Keeper Blocks – 13mm

AUTOMOTIVE METRIC
NAAMS STANDARD

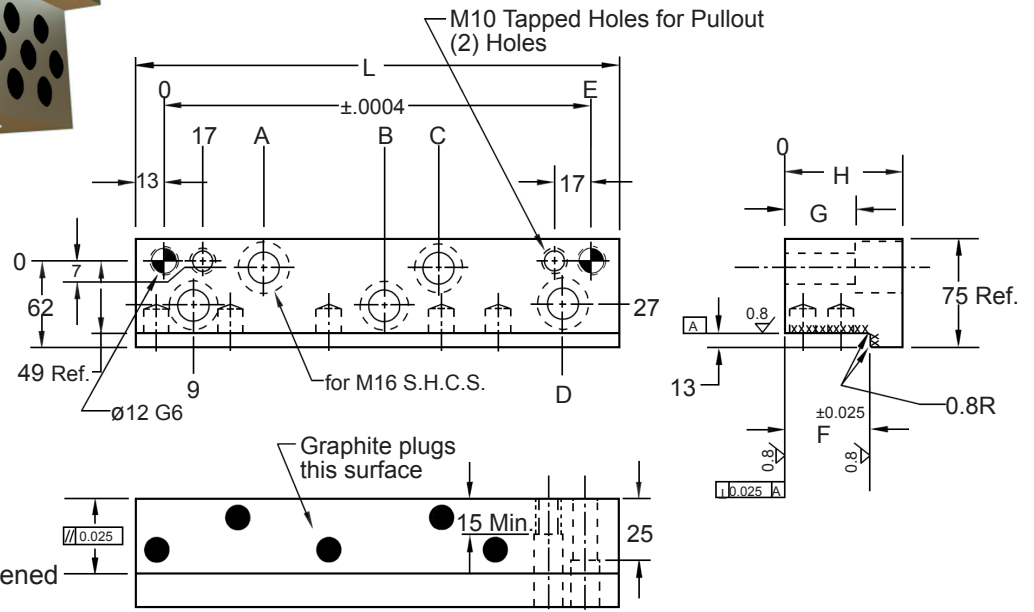
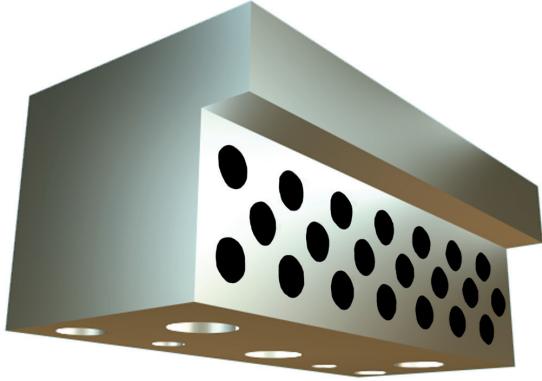

NOTES & SPECIFICATIONS:

- ◆ Screw hole locations ±0.25
- ◆ Dowel hole locations ±0.10
- ◆ Material: Steel
- ◆ Cross-hatched areas surface hardened

KEEPER BLOCKS – SOLID-STEEL – SELF-LUBRICATING – 13mm																					
PART NUMBER	(N) HOLES	L	A	B	C	D	E	F	G	H	PART NUMBER	(N) HOLES	L	A	B	C	D	E	F	G	H
			±0.25											±0.025	±0.25						
R023510	2	100	-	-	-	65	74	35	25	50	R025510	2	100	-	-	-	65	74	55	35	80
R023512	3	125	49.5	-	-	90	99				R025512	3	125	49.5	-	-	90	99			
R023515	3	150	62.0	-	-	115	124				R025515	3	150	62.0	-	-	115	124			
R023520	4	200	62.0	-	112	165	174				R025520	4	200	62.0	-	112	165	174			
R023522	5	225	62.0	99.5	137	190	199				R025522	5	225	62.0	99.5	137	190	199			
R023525	5	250	62.0	112.0	162	215	224				R025525	5	250	62.0	112.0	162	215	224			
R023530	5	300	62.0	137.0	212	265	274				R025530	5	300	62.0	137.0	212	265	274			
R024010	2	100	-	-	-	65	74	40	25	60	R026510	2	100	-	-	-	65	74	65	45	90
R024012	3	125	49.5	-	-	90	99				R026512	3	125	49.5	-	-	90	99			
R024015	3	150	62.0	-	-	115	124				R026515	3	150	62.0	-	-	115	124			
R024020	4	200	62.0	-	112	165	174				R026520	4	200	62.0	-	112	165	174			
R024022	5	225	62.0	99.5	137	190	199				R026522	5	225	62.0	99.5	137	190	199			
R024025	5	250	62.0	112.0	162	215	224				R026525	5	250	62.0	112.0	162	215	224			
R024030	5	300	62.0	137.0	212	265	274				R026530	5	300	62.0	137.0	212	265	274			
R025010	2	100	-	-	-	65	74	50	30	70	R027510	2	100	-	-	-	65	74	75	45	100
R025012	3	125	49.5	-	-	90	99				R027512	3	125	49.5	-	-	90	99			
R025015	3	150	62.0	-	-	115	124				R027515	3	150	62.0	-	-	115	124			
R025020	4	200	62.0	-	112	165	174				R027520	4	200	62.0	-	112	165	174			
R025022	5	225	62.0	99.5	137	190	199				R027522	5	225	62.0	99.5	137	190	199			
R025025	5	250	62.0	112.0	162	215	224				R027525	5	250	62.0	112.0	162	215	224			
R025030	5	300	62.0	137.0	212	265	274				R027530	5	300	62.0	137.0	212	265	274			

NAAMS U & V Blocks – Metric

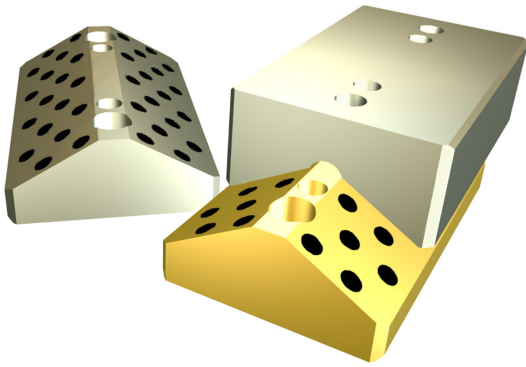

PRODUCT FEATURES

These 65, 75, 125 and 175mm U and V Blocks are manufactured to metric dimensions and fully meet the NAAMS standard. The U Block is manufactured from hardened steel. The V block is self-lubricating in design and is available in either bronze with oil-impregnated graphite plugs or steel with oil-impregnated graphite plugs.

FIGURE A - Steel U Block

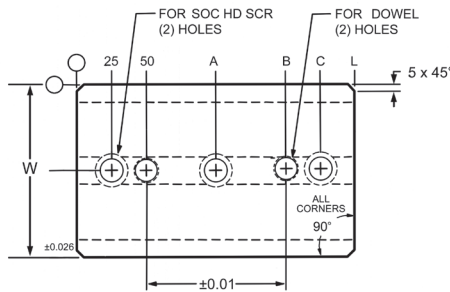

FIGURE B - Self-lubricating V Block

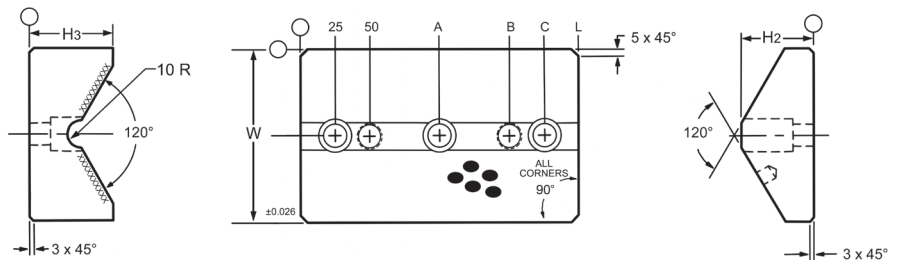
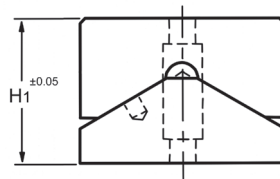

FIGURE C - Assembly



MATERIALS:

- ◆ U Blocks are manufactured from high quality carburized steel. They are precision ground and hardened to Rc56-62.
- ◆ V Blocks are manufactured from bronze material with oil impregnated graphite plugs or steel with oil-impregnated graphite plugs.

TOLERANCES:

- ◆ Between screw holes ± 0.12mm
- ◆ Between dowel holes ± 0.10mm
- ◆ Unless otherwise noted ± 0.25mm

RECOMMENDED MOUNTING SCREWS & DOWELS:

- ◆ **65mm blocks:** M12 S.H.C.S./M12 DOWELS
- ◆ **75mm blocks:** M12 S.H.C.S./M12 DOWELS
- ◆ **125mm blocks:** M16 S.H.C.S. M16 DOWELS
- ◆ **175mm blocks:** M16 S.H.C.S. M16 DOWELS

NAAMS U & V Blocks – Metric

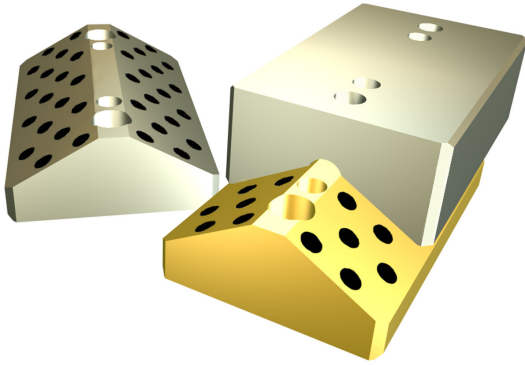

FIGURE A - Steel U Block

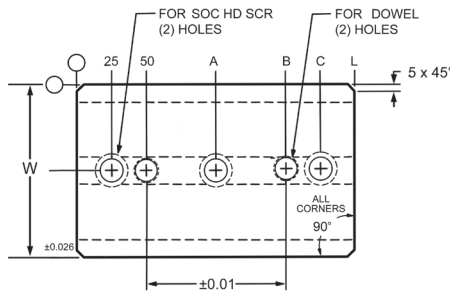

FIGURE B - Self-lubricating V Block

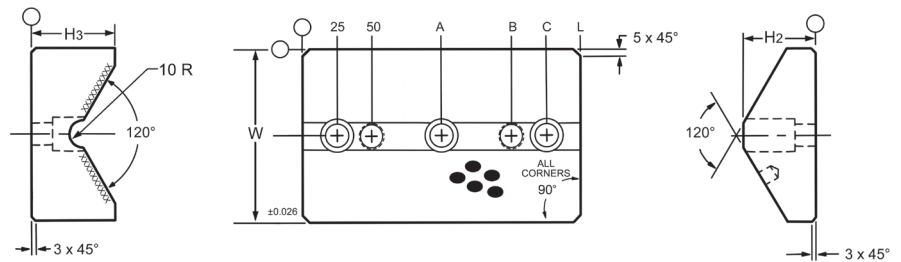
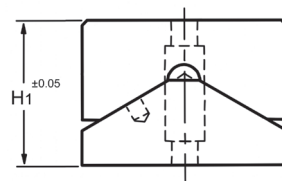

FIGURE C - Assembly



U Block	Steel V Block	Bronze V Block	Width W (mm)	Length L (mm)	Hole Qty.	A (mm)	B (mm)	C (mm)	H1 (mm)	H2 (mm)	H3 (mm)
G157515	G167515	G177515	65	150	2	–	100	125	65	39	40
G157520	G167520	G177520	65	200	2	–	150	175	65	39	40
G157525	G167525	G177525	65	250	3	125	200	225	65	39	40
G157530	G167530	G177530	65	300	3	150	250	275	65	39	40
G217515	G227515	G237515	75	150	2	–	100	125	65	39	40
G217520	G227520	G237520	75	200	2	–	150	175	65	39	40
G217525	G227525	G237525	75	250	3	125	200	225	65	39	40
G217530	G227530	G237530	75	300	3	150	250	275	65	39	40
G311215	G321215	G331215	125	150	2	–	100	125	85	52	60
G311220	G321220	G331220	125	200	2	–	150	175	85	52	60
G311225	G321225	G331225	125	250	3	125	200	225	85	52	60
G311230	G321230	G331230	125	300	3	150	250	275	85	52	60
G341715	G351715	G361715	175	150	2	–	100	125	110	67	80
G341720	G351720	G361720	175	200	2	–	150	175	110	67	80

Center Keys & Guides

AUTOMOTIVE METRIC
NAAMS STANDARD

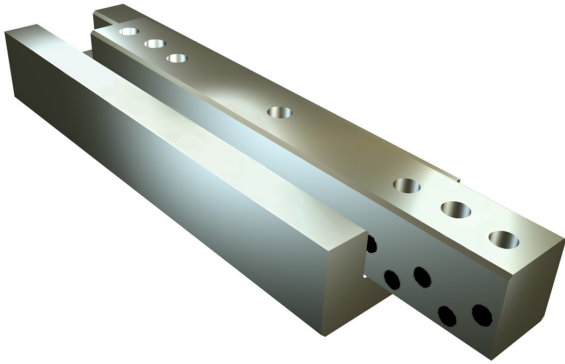

CENTER KEY GUIDE (G41)

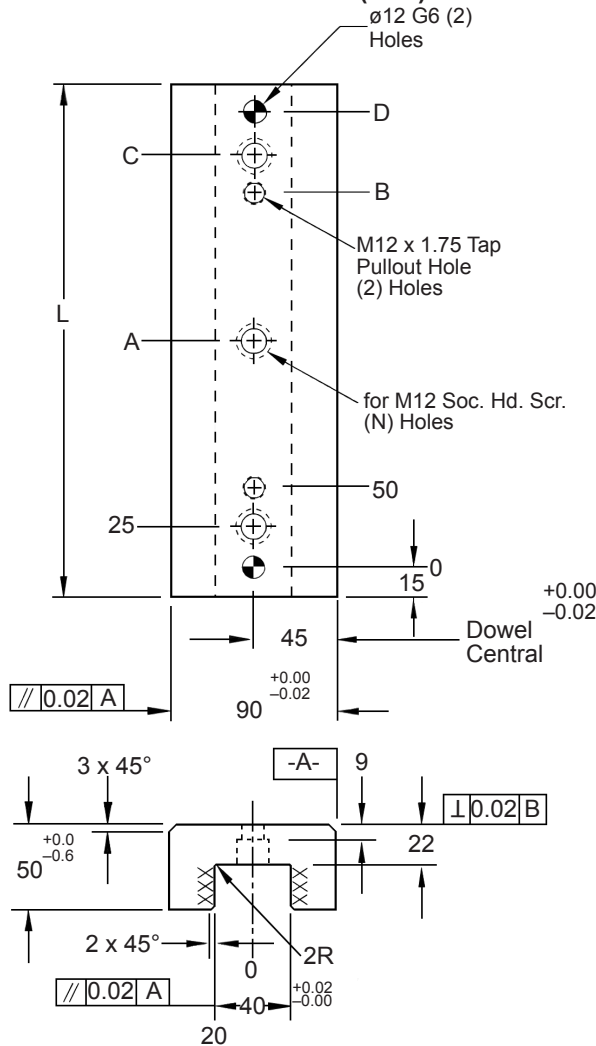

CENTER KEY (G42 & 43)

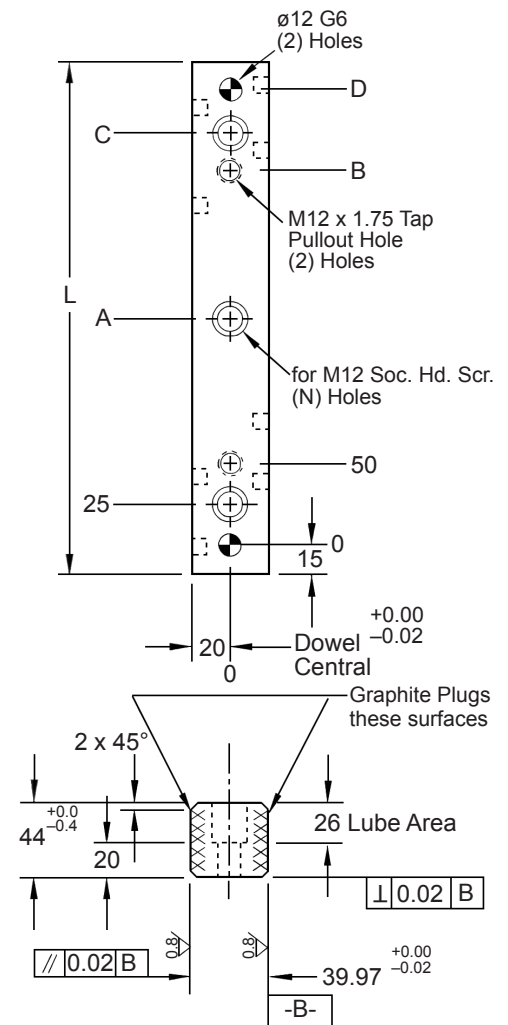

X Steel

Y Bronze Self-Lubricating

CENTER KEYS & GUIDES – METRIC							
NAAMS CODE (X)	NAAMS CODE (Y)	A	B	C	D	L	"N"
G419020	-	-	120	145	170	200	2
G419030	-	135	220	245	270	300	3
G424020	G434020	-	120	145	170	200	2
G424030	G434030	135	220	245	270	300	3

NOTES & SPECIFICATIONS:

- ◆ Screw hole locations ± 0.25
- ◆ Dowel hole locations ± 0.10
- ◆ Material: Steel
- ◆ Cross-hatched areas surface hardened

SOLUTIONS TO FIT YOUR SPECIAL APPLICATIONS

In addition to “made to print” specials, a wide range of catalog components can be modified to meet customer specific applications. Round, flat, simple or complex, we want to make those one-of-a-kind parts for you.

At Lamina, our focus is on offering specials to you quickly and at a reasonable price.

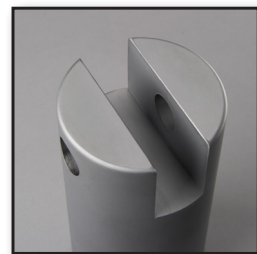

Please send your prints and requests for quotation to sales@lamina.com.

Commitment to Quality & Customer Satisfaction

Dayton Lamina is a leading manufacturer of tool, die and mold components for the metal-working and plastics industries. As a customer-focused, world-class supplier of choice, we provide the brands, product breadth, distribution network and technical support for all your metal forming needs.

Our goal is to give our customers the most innovative and value-added products and services.



DAYTON Lamina™



Lamina® LEMPCO

*Dayton Lamina's line of Danly products is available only to North America.

www.daytonlamina.com